

# LIGHTING CATALOGUE

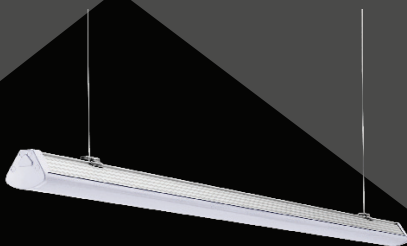

EUROPEANLED

2023-2024

# ΚΑΤΗΓΟΡΙΕΣ ΠΡΟΪΟΝΤΩΝ

LC ... 	LC ... 	LL ... 	LL ... 	LL ... 	LL ... 
AMBER	COG	C37 / C37 flame	G45	A60 / A65	Globe / R50

LL ... 	LL ... 	LL ... 	LHL ... 	LL ... 	LT ... 
MR16	ES111	S2	High Power LED light	G4 / G9	T8

HDL.. 	HD.. 	30-60 LED.. 	2 ΠΡΟΒ.. 	CINCA.. 	966 ... 
ΣΚΑΦΑΚΙΑ T8	T5 ΦΩΤΙΣΤΙΚΟ	ΕΠΑΝΑΦ. ΦΑΝΟΣ	ΕΠΑΝΑΦ. ΦΑΝΟΣ 2ΠΡ.	ΦΩΤ. ΑΣΦΑΛΕΙΑΣ	ΦΩΤ. ΓΡΑΦΕΙΟΥ

HFL.. 	HFL.S 	LFL ... 	LFL.S 	LFL ... 	LFL ... 
ΠΡΟΒ.LED	ΠΡΟΒ.LED SENSOR	PLATI	PLATI LED SENSOR	GALAXI	GALAXI PIR SENSOR

LFS ... 	LUS ... 	LFP ... 	LFL ... 	LFL ... 	HHB.. 
SOLAR	SOLAR RX	GALAXI P	LUMI	TRENTI	HIGH BAY

HTR.. 	HPL.. 	HDS.. 	HTP ... 	LHT ... 	LHT ... 
ΠΡΟΒ.ΡΑΓΑΣ LED	PANEL LED	ΦΩΤ.ΟΡΟΦΗΣ	ΦΩΤ.ΟΡΟΦΗΣ ΣΥΝΔΕΟΜΕΝΟ	Linea	Linea

LHT ... 	HCL ... 	LO.. 	HBL ... 	LOR... 	LO ... 
Linea+	ΦΩΤ. ΟΡΟΦΗΣ	ΦΩΤ. ΟΡΟΦΗΣ VERA	ΠΛΑΦΟΝΙΕΡΑ	SPHERE III	SPHERE

Θερμοκρασία Λευκού Χρώματος

● cool ψυχρό  
● natural φυσικό  
● warm θερμό

# ΚΑΤΗΓΟΡΙΕΣ ΠΡΟΪΟΝΤΩΝ

LO ... 	LO ... 	HDW... 	HDW... 	HDC... 	LOP ... 
AMBID I	RING	ΧΩΝΕΥΤΑ ΣΠΟΤ	ΧΩΝΕΥΤΟ ΦΩΤ.ΟΡΟΦ.	ΦΩΤ. ΟΡΟΦΗΣ	SUPREMO
LOR ... 	LOR ... 	LIL ... 	LOE ... 	LGR ... 	LGR ... 
RONDO II	RONDO SHINE	KRONA	ASTON	GANDA	LUMIA
LOB ... 	LOB ... 	LOB ... 	LPO ... 	LPO ... 	LU ... 
AUDOR	PRIMA	TORA	PARK MR	PARK MA	ΦΩΤ. ΔΡΟΜΟΥ PX
LU ... 		LU ... 	LU ... 	LFL ... 	LFL ... 
ΦΩΤ. ΔΡΟΜΟΥ MA	Street MKB	Street HD	Street Cross MS	AREA FL02	AREA FL03
LFL ... 	LS ... 	LPSA/ LZT/ LS... 	Lx ... 	LO ... 	LO ... 
Stadium LIGHT	LED Strips	ΕΞΑΡΤΗΜΑΤΑ LED STRIPS	DAI CONTROL/ EXTENTIONS	SPHERE II	OVAL
LO ... 	LO ... 	LFL ... 	LOR ... 	LHT ... 	LHL ... 
ALDAR	CYDER	AKRON	Panel LED Disc	Retro	ECO Line I
LEL ... 	LPL ... 	LHB ... 	LHB ... 	LHB ... 	LHB ... 
ECO Line II	ECO Line III	HIRACK	High Bay COMPACT MKB	High Bay COMPACT S	High Bay COMPACT IV

Θερμοκρασία Λευκού Χρώματος

● ● ●  
cool natural warm  
ψυχρό φυσικό θερμό

# LED ΛΑΜΠΤΗΡΕΣ - COG AMBER

**LUMAX**  
Bright side of life

## Διακοσμητικοί Λαμπτήρες



20 000 h

>10 000

100% (<1s)



**ICDriver**  
No Flickering



**360°** ST64  
8W

**360°** ST64  
12W

**360°** G125  
8W

**360°** G125  
12W

● **LC150**  
8W

● **LC151**  
12W

● **LC160**  
8W

● **LC161**  
12W

ΚΩΔ.	Μοντέλο	Τύπος	WATT	Lumen	WATT	CRI	360°	Volt	FAN	EEI	↔
20.63.0007	LC150	LED COG AMBER	E27	7W	700lm	54W	2200K ● >80	360°	220-240V	5901087205263	F ø 64x146mm
20.63.0008	LC151	LED COG AMBER	E27	12W	1300lm	88W	2200K ● >80	360°	170-265V	5901087205270	F ø 64x146mm
20.63.0009	LC160	LED COG AMBER	E27	7W	700lm	54W	2200K ● >80	360°	220-240V	5901087205287	F ø 125x175mm
20.63.0010	LC161	LED COG AMBER	E27	12W	1300lm	88W	2200K ● >80	360°	170-265V	5901087205294	F ø 125x175mm



# LED ΛΑΜΠΤΗΡΕΣ - COG

20 000 h

&gt;10 000

100% (&lt;1s)

**IC Driver**  
No Flickering

2700 K

**C37**  
360°  
6W

 ● **LC052**  
6W

**C37 flame**  
360°  
6W

 ● **LC053**  
6W

**G45**  
360°  
6W

 ● **LC062**  
6W

**A60**  
360°  
6W  
8W

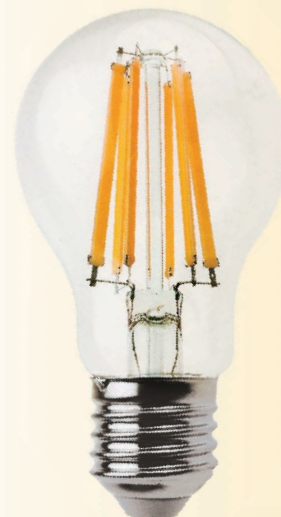
 ● **LC110**  
6W  
● **LC111**  
8W

**A60**  
360°  
12W

 ● **LC112**  
12W

ΚΩΔ.	Μοντέλο	Τύπος	WATT	Lumen		2700K ●	>80	360°	Volt	FAN	EEI	
20.63.0001	LC052	LED COG	E14 6W	800lm	60W	2700K ●	>80	360°	220-240V	5901087205218	E	ø 35x98mm
20.63.0002	LC053	LED COG	E14 6W	800lm	60W	2700K ●	>80	360°	220-240V	5901087205225	E	ø 35x120mm
20.63.0003	LC062	LED COG	E14 6W	800lm	60W	2700K ●	>80	360°	220-240V	5901087205232	E	ø 45x80mm
20.63.0004	LC110	LED COG	E27 6W	600lm	48W	2700K ●	>80	360°	220-240V	5907377254775	F	ø 60x110mm
20.63.0005	LC111	LED COG	E27 8W	1000lm	72W	2700K ●	>80	360°	220-240V	5901087205249	E	ø 60x110mm
20.63.0006	LC112	LED COG	E27 12W	1500lm	99W	2700K ●	>80	360°	170-256V	5901087205256	E	ø 60x110mm

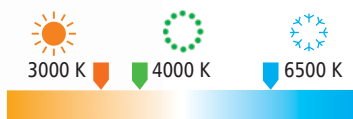

LED ΛΑΜΠΤΗΡΕΣ - C37 & G45  
ΑΠΑΛΟ ΦΩΣ ΧΩΡΙΣ ΝΑ ΤΡΕΜΟΠΑΙΖΕΙ



LED Λαμπτήρες - C37, G45

ΚΩΔ.	Μοντέλο	Τύπος	Watt	Βάση	Lumen	Voltage	CRI	Γωνία Δέσμης	Θερμοκρασία Λευκού	Διάρκεια Ζωής	ON/OFF	Μέγεθος Λάμπας
20.61.0039	HD021	C37	3W	E14	250	175-250V	>80	200°	3000K	25000 h	>15 000	37x131mm
20.61.0004	HD053	C37	6W	E14	510	220-240V	>80	200°	3000K	25000 h	>15 000	37x100mm
20.61.0005	HD058	C37	6W	E14	510	220-240V	>80	200°	4000K	25000 h	>15 000	37x100mm
20.61.0006	HD060	C37	6W	E14	510	220-240V	>80	200°	6500K	25000 h	>15 000	37x100mm
20.61.0009	HD055	C37	8W	E14	806	220-240V	>80	200°	3000K	25000 h	>15 000	37x108mm
20.61.0014	HD077	C37	8W	E14	806	220-240V	>80	200°	4000K	25000 h	>15 000	37x108mm
20.61.0013	HD066	C37	8W	E14	806	220-240V	>80	200°	6500K	25000 h	>15 000	37x108mm
20.61.0001	HD050	G45	6W	E14	510	220-240V	>80	200°	3000K	25000 h	>15 000	45x78mm
20.61.0002	HD051	G45	6W	E14	510	220-240V	>80	200°	4000K	25000 h	>15 000	45x78mm
20.61.0008	HD063	G45	6W	E14	510	220-240V	>80	200°	6500K	25000 h	>15 000	45x78mm
20.61.0003	HD052	G45	6W	E27	510	220-240V	>80	200°	3000K	25000 h	>15 000	45x76mm
20.61.0007	HD062	G45	6W	E27	510	220-240V	>80	200°	6500K	25000 h	>15 000	45x76mm
20.61.0010	HD056	G45	8W	E14	806	220-240V	>80	200°	3000K	25000 h	>15 000	45x78mm
20.61.0011	HD057	G45	8W	E14	806	220-240V	>80	200°	4000K	25000 h	>15 000	45x78mm
20.61.0012	HD065	G45	8W	E14	806	220-240V	>80	200°	6500K	25000 h	>15 000	45x78mm

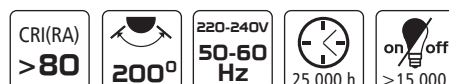

**LED ΛΑΜΠΤΗΡΕΣ - A55, A60 & A65**  
**ΑΠΑΛΟ ΦΩΣ ΧΩΡΙΣ ΝΑ ΤΡΕΜΟΠΑΙΖΕΙ**

**LED Λαμπτήρες - A55, A60 & A65**

ΚΩΔ.	Μοντέλο	Τύπος	Watt	Βάση	Lumen	Voltage	CRI	Γωνία Δέσμης	Θερμοκρασία Λευκού	Διάρκεια Ζωής	ON/OFF	Μέγεθος Λάμπας
20.61.0015	HD100	A55	7W	E27	600	220-240V	>80	200°	3000K	25000 h	>15 000	55x100mm
20.61.0037	HD120	A55	7W	E27	605	220-240V	>80	200°	4000K	25000 h	>15 000	55x100mm
20.61.0016	HD110	A55	7W	E27	630	220-240V	>80	200°	6500K	25000 h	>15 000	55x100mm
20.61.0019	HD121	A60	8.5W	E27	810	220-240V	>80	200°	4000K	25000 h	>15 000	60x108mm
20.61.0017	HD101	A60	9W	E27	806	220-240V	>80	200°	3000K	25000 h	>15 000	60x108mm
20.61.0018	HD111	A60	9W	E27	815	220-240V	>80	200°	6500K	25000 h	>15 000	60x108mm
20.61.0020	HD102	A60	11W	E27	1050	220-240V	>80	200°	3000K	25000 h	>15 000	60x110mm
20.61.0022	HD122	A60	11W	E27	1055	220-240V	>80	200°	4000K	25000 h	>15 000	60x110mm
20.61.0021	HD112	A60	11W	E27	1080	220-240V	>80	200°	6500K	25000 h	>15 000	60x110mm
20.61.0023	HD103	A65	15W	E27	1500	220-240V	>80	200°	3000K	25000 h	>15 000	65x134mm
20.61.0025	HD123	A65	15W	E27	1520	220-240V	>80	200°	4000K	25000 h	>15 000	65x134mm
20.61.0024	HD113	A65	15W	E27	1570	220-240V	>80	200°	6500K	25000 h	>15 000	65x134mm
20.61.0026	HD105	A65	17W	E27	1710	220-240V	>80	200°	3000K	25000 h	>15 000	65x134mm
20.61.0038	HD125	A65	17W	E27	1720	220-240V	>80	200°	4000K	25000 h	>15 000	65x134mm
20.61.0027	HD115	A65	17W	E27	1750	220-240V	>80	200°	6500K	25000 h	>15 000	65x134mm

Περιβλήμα - θερμικά αγωγίμο πλαστικό + ψύκτρα αλουμινίου

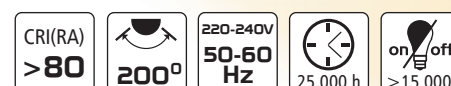

## LED ΛΑΜΠΤΗΡΕΣ - G120 / R50

**LUMAX**  
Bright side of life

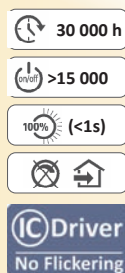

**G120**  
19W

- LL107
- LL107C

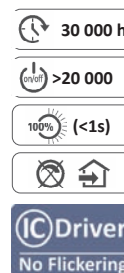

**R50**  
6W

- LL096
- LL096N
- LL096C

ΚΩΔ.	Μοντέλο	Τύπος	WATT	Lumen	WATT	CRI	Beam	Volt	EAN	EEI	Dimensions	
20.63.0077	LL107	G120	E27	19W	2000lm	126W	3000K	>80	120°	175-265V	5901087203047	F ø 120x160mm
20.63.0078	LL107C	G120	E27	19W	2000lm	126W	6500K	>80	120°	175-265V	5901087203054	F ø 120x160mm
20.63.0079	LL096	R50	E14	6W	470lm	40W	3000K	>80	200°	175-250V	5907377250944	G ø 50x83mm
20.63.0081	LL096N	R50	E14	6W	475lm	40W	4000K	>80	200°	175-250V	5907377252955	G ø 50x83mm
20.63.0080	LL096C	R50	E14	6W	475lm	40W	6500K	>80	200°	175-250V	5907377252962	G ø 50x83mm

## LED ΛΑΜΠΤΗΡΑΣ ΜΕ PIR ΑΙΣΘΗΤΗΡΑ ΚΙΝΗΣΗΣ ΑΠΑΛΟ ΦΩΣ ΧΩΡΙΣ ΝΑ ΤΡΕΜΟΠΑΙΖΕΙ

**heda**  
EUROPEAN  
LED

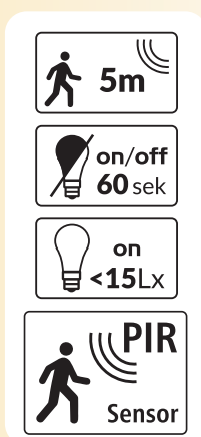

**A60**



### LED Λαμπτήρας - A60

ΚΩΔ.	Μοντέλο	Τύπος	Watt	Βάση	Lumen	Voltage	CRI	Γωνία δέσμης	Θερμοκρασία	Διάρκεια ζωής	ON/OFF	Μέγεθος λάμπας
20.61.0022	HD122S	A60	12W	E27	1200	220-240V	>80	200°	4000K	25000 h	>15 000	60x126mm
20.61.0021	HD112S	A60	12W	E27	1200	220-240V	>80	200°	6500K	25000 h	>15 000	60x126mm



## LED ΛΑΜΠΤΗΡΕΣ MR16/GU10

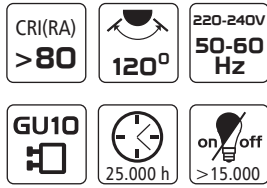

MR16

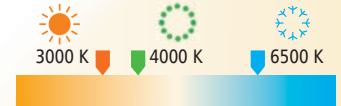

Περιβλημα - θερμικά αγώγιμο πλαστικό + ψύκτρα αλουμινίου

ΚΩΔ.	Μοντέλο	Τύπος	Watt	Βάση	Lumen	Voltage	CRI	Γωνία Δέσμης	Θερμοκρασία Λευκού	Διάρκεια Ζωής	ON/OFF	Μέγεθος λάμπας
20.61.0030	HD221	MR16	4W	GU10	310	220-240V	>80	120°	6500K	25000h	>15 000	50x56mm
20.61.0029	HD220	MR16	4,5W	GU10	400	220-240V	>80	120°	3000K	25000h	>15 000	50x56mm
20.61.0031	HD230	MR16	5,5W	GU10	500	220-240V	>80	120°	3000K	25000h	>15 000	50x56mm
20.61.0033	HD232	MR16	5,5W	GU10	510	220-240V	>80	120°	4000K	25000h	>15 000	50x56mm
20.61.0032	HD231	MR16	5,5W	GU10	515	220-240V	>80	120°	6500K	25000h	>15 000	50x56mm
20.61.0034	HD243	MR16	7,5W	GU10	700	220-240V	>80	120°	3000K	25000h	>15 000	50x56mm
20.61.0036	HD245	MR16	7,5W	GU10	700	220-240V	>80	120°	4000K	25000h	>15 000	50x56mm
20.61.0035	HD244	MR16	7,5W	GU10	720	220-240V	>80	120°	6500K	25000h	>15 000	50x56mm

## LED ΛΑΜΠΤΗΡΕΣ - MR16RC/GU5.3



GU5.3  
● LL064  
● LL065  
4W

120°



GU10  
● LL330  
● LL331  
● LL332  
10W

120°



30 000 h

>15 000

100% (<1s)



Γυάλινο σώμα

ΚΩΔ.	Μοντέλο	Τύπος	WATT	Lumen	CRI	Beam	Volt	FAN	EEL	Size
20.63.0011	LL064	MR16 RC	4W	300lm	3000K	>80	120°	12V	G	ø 50x49mm
20.63.0012	LL065	MR16 RC	4W	320lm	6500K	>80	120°	12V	G	ø 50x49mm
20.63.0026	LL330	MR16 IC	10W	1000lm	3000K	>80	120°	220-240V	F	ø 50x56mm
20.63.0027	LL331	MR16 IC	10W	1000lm	4000K	>80	120°	220-240V	F	ø 50x56mm
20.63.0028	LL332	MR16 IC	10W	1000lm	6500K	>80	120°	220-240V	F	ø 50x56mm

## LED ΛΑΜΠΤΗΡΕΣ - ES111/ GU10



LL516



LL517



LL516 ES111 12W 90°



LL510 ES111 15W 60°



LL515 ES111 15W 18W 38°



LL517 ES111 12W 45°

20 000 h

>15 000

100% (<1s)



ΚΩΔ.	Μοντέλο	Τύπος	WATT	Lumen	CRI	Beam	Volt	FAN	EEL	Size
20.63.0096	LL516	LED ES111	12W	950lm	4100K	>80	90°	175-265V	G	ø 110x58mm
20.63.0094	LL510	LED ES111	15W	1200lm	4100K	>80	60°	175-256V	G	ø 111x58mm
20.63.0097	LL517	LED ES111	12W	1000lm	4000K	>80	45°	220-240V	F	ø 111x73mm
20.63.0095	LL515	LED ES111	18W	1450lm	4100K	>80	38°	100-256V	F	ø 110x58mm

## LED ΛΑΜΠΤΗΡΕΣ - S2

**LUMAX**  
Bright side of life

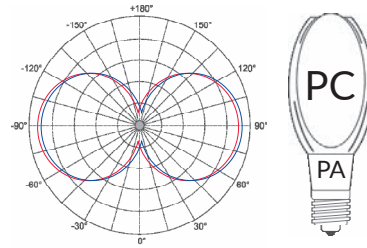

- 25 000 h
- >12 500
- 100% (<1s)
- IC Driver  
No Flickering

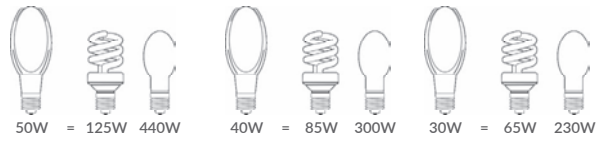
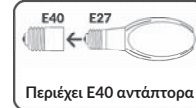

- LL731 50W
- LL732 50W
- LL721 40W
- LL722 40W
- LL711 30W
- LL712 30W

Λάμπες δρόμου, πάρκων

ΚΩΔ.	Μοντέλο	Τύπος	WATT	Lumen	COS Φ Power Factor	CRI	Beam Spread	Volt	FAN	EEL	Dimensions
20.63.0102	LL731	S2 E27/E40	50W	7500lm	>0,9	4000K	>80	340°	220-240V	D	ø 108x264mm
20.63.0103	LL732	S2 E27/E40	50W	7500lm	>0,9	6500K	>80	340°	220-240V	D	ø 108x264mm
20.63.0100	LL721	S2 E27/E40	40W	5200lm	>0,9	4000K	>80	340°	220-240V	E	ø 96x228mm
20.63.0101	LL722	S2 E27/E40	40W	5200lm	>0,9	6500K	>80	340°	220-240V	E	ø 96x228mm
20.63.0098	LL711	S2 E27	30W	3900lm	>0,9	4000K	>80	340°	220-240V	E	ø 96x228mm
20.63.0099	LL712	S2 E27	30W	3900lm	>0,9	6500K	>80	340°	220-240V	E	ø 96x228mm

## ΥΨΗΛΗΣ ΙΣΧΥΟΣ LED ΠΗΓΗ ΦΩΤΙΣΜΟΥ - V1

**LUMAX**  
Bright side of life

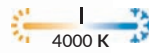

- lumen 10800 Fixture
- 176-264V 50/60 Hz
- 120°
- CRI(RA) >80
- Kelvin 4000
- F
- Hg
- PF >0,9

- 30 000 h
- >20 000
- 100% (<1s)
- IC Driver  
No Flickering

OPTIONAL  
5 years  
Guarantee

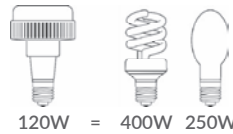

WATT 120W  
9-10 m

LHL120K Lampshade



PC



LHL120 120W

Χρησιμοποιείστε το κάλυμμα για δέσμη 90°

ΚΩΔ.	Μοντέλο	Τύπος	WATT	Lumen	IP	CRI	Beam Spread	Volt	EAN	EEL	Dimensions
20.63.0104	LHL120	V1	E40 120W	10800lm	20	4000K	>80	120°	176-264 V	F	ø 230x306mm
20.66.0014	LHL120K	Lampshade for V1					90°		5901087201982		-

**LED ΛΑΜΠΤΗΡΕΣ - G4 / G9**

**25 000 h**
**>10 000**
**100% (<1s)**

**LL250** ●  
2,5W  
200 lm

**LL245** ● **LL246** ● **LL247** ●  
4,5W 4,5W 4,5W  
480 lm 480 lm 480 lm

**25 000 h**
**>15 000**
**100% (<1s)**

**LL231** ● **LL232** ●  
4,5W 4,5W  
450 lm 450 lm

**LL234** ● **LL235** ●  
8W 8W  
800 lm 800 lm

**LL237** ● **LL238** ●  
12W 12W  
1200 lm 1200 lm

KΩΔ.	Μοντέλο	Τύπος		WATT				CRI					
20.63.0093	LL250	G4 silicon	G4	2,5W	200lm	21W	3000K ●	>80	360°	12 V AC/DC	5907377258414	G	ø 16x42mm
20.63.0090	LL245	G9 glass	G9	4,5W	480lm	40W	3000K ●	>80	360°	220-240 V	5901087200992	F	ø 16x59,5mm
20.63.0091	LL246	G9 glass	G9	4,5W	480lm	40W	4000K ●	>80	360°	220-240 V	5901087201005	F	ø 16x59,5mm
20.63.0092	LL247	G9 glass	G9	4,5W	480lm	40W	6500K ●	>80	360°	220-240 V	5901087201012	F	ø 16x59,5mm
20.63.0083	LL231	G9 plastic	G9	4,5W	450lm	39W	3000K ●	>80	360°	220-240 V	5907377258476	F	ø 17,5x55mm
20.63.0084	LL232	G9 plastic	G9	4,5W	450lm	39W	4000K ●	>80	360°	220-240 V	5901087206345	F	ø 17,5x55mm
20.63.0085	LL234	G9 plastic	G9	8 W	800lm	60W	3000K ●	>80	360°	220-240 V	5901087206352	F	ø 18,5x63mm
20.63.0086	LL235	G9 plastic	G9	8 W	800lm	60W	4000K ●	>80	360°	220-240 V	5901087206369	F	ø 18,5x63mm
20.63.0087	LL237	G9 plastic	G9	12 W	1200lm	83W	3000K ●	>80	360°	220-240 V	5901087206376	F	ø 24x65mm
20.63.0088	LL238	G9 plastic	G9	12 W	1200lm	83W	4000K ●	>80	360°	220-240 V	5901087206383	F	ø 24x65mm

## ΛΑΜΠΤΗΡΕΣ LED T8 SMD GLASS



Fireproof V1



**T8** | PF >0.7 | CRI(RA) >80 | 180° | 220-240V 50-60 Hz | G13 | 25.000 h | on/off >15.000

4000 K natural light | cold light 6500 K | 4000 K natural light | cold light 6500 K | cold light 6500 K | 4000 K natural light

Watt	9W	9W	18W	18W	20W	22W
Lumen	900	900	1850	1850	2100	2300
Voltage	220-240V	220-240V	220-240V	220-240V	220-240V	220-240V
CRI	>80	>80	>80	>80	>80	>80
Γωνία δέσμης	180°	180°	180°	180°	180°	180°
Θερμοκρασία	4000 K	6500 K	4000 K	6500 K	6500 K	6500 K
Διάρκεια ζωής	25 000 H	25 000 H	25 000 H	25 000 H	25 000 H	25 000 H
ON/OFF	> 15 000	> 15 000	> 15 000	> 15 000	> 15 000	> 15 000
Μέγεθος λάμπας	600 mm	600 mm	1200 mm	1200 mm	1500 mm	1500 mm
<b>ΚΩΔ.</b>	<b>20.61.0302</b>	<b>20.61.0301</b>	<b>20.61.0304</b>	<b>20.61.0303</b>	<b>20.61.0305</b>	<b>20.61.0306</b>
<b>Μοντέλο</b>	<b>HDT109NGL</b>	<b>HDT109CGL</b>	<b>HDT118NGL</b>	<b>HDT118CGL</b>	<b>HDT120CGL</b>	<b>HDT122NGL</b>

Να μην χρησιμοποιείτε με ηλεκτρονικό ή μαγνητικό ballast. Αφαιρέστε το ballast πριν την εγκατάσταση.

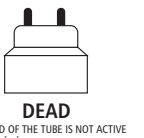
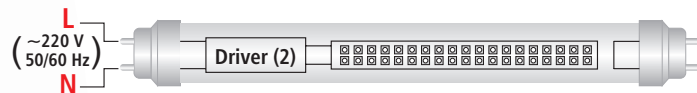
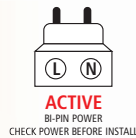

## ΛΑΜΠΤΗΡΕΣ LED T8 HIGH EFFICIENCY



Fireproof V1



**High Efficiency!**  
**150lm/W**  
**PF > 0,9**

**1500lm** **LT501GL** **10W** | 3000 K  
**2700lm** **LT505GL** **18W** | 4100 K  
**3600lm** **LT509GL** **24W** | 6500 K

**T8** | ACBS-265V 50/60 Hz | lumen | Kelvin | 270° | <cm> | W | CRI(RA) | Hg

25 000 h | >15 000 | 100% (<1s) |

ΚΩΔ.	Μοντέλο	Τύπος	G13	WATT	Lumen	30W	3000K	CRI	270°	Volt	FAN	EEI	60cm
20.63.0463	LT501GL	TUBA LED Glass T8	G13	10W	1500lm	30W	3000K	>80	270°	220-240V	---	D	60cm
20.63.0457	LT502GL	TUBA LED Glass T8	G13	10W	1500lm	30W	4100K	>80	270°	220-240V	5901087202187	D	60cm
20.63.0458	LT503GL	TUBA LED Glass T8	G13	10W	1500lm	30W	6500K	>80	270°	220-240V	5901087202194	D	60cm
20.63.0464	LT504GL	TUBA LED Glass T8	G13	18W	2700lm	50W	3000K	>80	270°	220-240V	---	D	120cm
20.63.0459	LT505GL	TUBA LED Glass T8	G13	18W	2700lm	50W	4100K	>80	270°	220-240V	5901087202200	D	120cm
20.63.0460	LT506GL	TUBA LED Glass T8	G13	18W	2700lm	50W	6500K	>80	270°	220-240V	5901087202217	D	120cm
20.63.0465	LT507GL	TUBA LED Glass T8	G13	24W	3600lm	80W	3000K	>80	270°	220-240V	---	D	150cm
20.63.0461	LT508GL	TUBA LED Glass T8	G13	24W	3600lm	80W	4100K	>80	270°	220-240V	5901087202224	D	150cm
20.63.0462	LT509GL	TUBA LED Glass T8	G13	24W	3600lm	80W	6500K	>80	270°	220-240V	5901087202231	D	150cm

## ΣΚΑΦΑΚΙΑ T8 BATTEN TYPE ΓΙΑ ΛΑΜΠΤΗΡΕΣ LED T8-G13



Κωδικός	Αριθμός Λαμπτήρων	Μήκος (cm)	Συσκ.
20.09.1391	1	60	50
20.09.1393	1	120	50
20.09.1394	1	150	50
20.09.1395	2	60	50
20.09.1397	2	120	50
20.09.1398	2	150	50

- Μονής τροφοδοσίας
- Δυνατότητα έξτρα ντουί για λάμπες αμφίπλευρης τροφοδοσίας
- Ηλεκτροστατική βαφή
- Βαθμός προστασίας: IP20
- Τροφοδοσία: 180-230V/ 50Hz



### ΝΤΟΥΙ ΓΙΑ ΣΚΑΦΑΚΙΑ T8

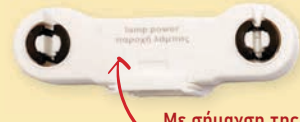

Με σήμανση της παροχής στο ντουί

ΚΩΔΙΚΟΣ	Τύπος	Συσκ.
20.10.1356	Μονό	1 τμχ
20.10.1358	Διπλό	1 τμχ

- Για λάμπες με τροφοδοσία στα 2 άκρα
- Με καλώδιο σύνδεσης

## ΣΚΑΦΑΚΙΑ T8 Dustproof



Τύπος Σκαφ.	2xT8 LED	2xT8 LED
Μέγεθος Σκαφ.	120 cm	120 cm
Αριθμός Σκαφ.	2	2
Βάση	G13	G13
IP	65	65
Μέγεθος λάμπας	1260x107x61mm	1260x107x61mm
Καθαρό βάρος	0,98 kg	0,98 kg

ΚΩΔ.

20.61.0351

20.61.0352

Μοντέλο

HDL236

HDL236RF



+ ΑΝΑΚΛΑΣΤΗΡΑΣ  
Αυξάνει την φωτεινή ροή

### ABS+PS

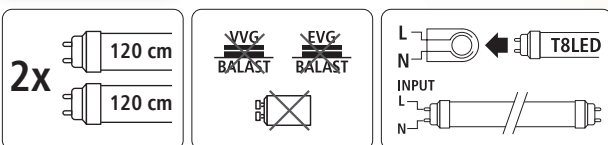

Το φωτιστικό δεν περιλαμβάνει λάμπες



## T5 LED ΦΩΤΙΣΤΙΚΑ ΜΕ ON/OFF ΔΙΑΚΟΠΗ



<b>8W</b>	IP 20 IK 02	680 lumen	180°	180-256V 50Hz	CRI(RA) >80	PF >0.5	25.000 h	on/off >15.000
-----------	----------------	--------------	------	------------------	----------------	------------	----------	-------------------

<b>10W</b>	IP 20 IK 02	850 lumen	180°	180-256V 50Hz	CRI(RA) >80	PF >0.5	25.000 h	on/off >15.000
------------	----------------	--------------	------	------------------	----------------	------------	----------	-------------------

<b>14W</b>	IP 20 IK 02	1180 lumen	180°	180-256V 50Hz	CRI(RA) >80	PF >0.5	25.000 h	on/off >15.000
------------	----------------	---------------	------	------------------	----------------	------------	----------	-------------------

### Περιλαμβανόμενα Εξαρτήματα



<b>Watt</b>	8W	8W	10/14W	10/14W	14W	14W
<b>Lumen</b>	900	900	850-1400	850-1400	1180	1180
<b>Voltage</b>	180-256V	180-256V	180-256V	180-256V	180-256V	180-256V
<b>CRI</b>	>80	>80	>80	>80	>80	>80
<b>Γωνία δέσμης</b>	180°	180°	180°	180°	180°	180°
<b>Θερμοκρασία</b>	4000 K	6500 K	4000 K	6500 K	4000 K	6500 K
<b>Διάρκεια ζωής</b>	25 000 H	25 000 H	25 000 H	25 000 H	25 000 H	25 000 H
<b>ON/OFF</b>	> 15000	> 15000	> 15000	> 15000	> 15000	> 15000
<b>Μέγεθος λάμπας</b>	60cm	60cm	90cm	90cm	120cm	120cm
<b>ΚΩΔ.</b>	20.61.0382	20.61.0381	20.61.0384	20.61.0383	20.61.0386	20.61.0385
<b>Μοντέλο</b>	HDT508N	HDT508C	HDT510N	HDT510C	HDT514N	HDT514C

## T5 LED ΦΩΤΙΣΤΙΚΑ ΜΕ ON/OFF ΔΙΑΚΟΠΤΗ

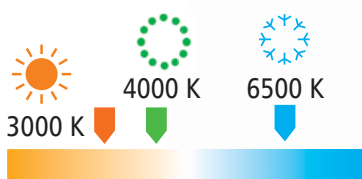

Με διακόπτη - Συμπεριλαμβάνει:

- 1m Καλώδιο τροφοδοσίας & καλώδιο σύνδεσης
- 30.000 ώρες λειτουργίας
- No flicker (δεν τρεμοπαίζει)
- IC driver
- EMC PASS
- 2 χρόνια εγγύηση



<b>4W</b>	IP 20 IK 02	400 lumen	140°	165-265V 50Hz	CRI(RA) >80	PF >0.5	30.000 h	on/off >15.000
<b>9W</b>	IP 20 IK 02	800 lumen	140°	165-265V 50Hz	CRI(RA) >80	PF >0.5	30.000 h	on/off >15.000
<b>14W</b>	IP 20 IK 02	1000 lumen	140°	165-265V 50Hz	CRI(RA) >80	PF >0.5	30.000 h	on/off >15.000
<b>18W</b>	IP 20 IK 02	1200 lumen	140°	165-265V 50Hz	CRI(RA) >80	PF >0.5	30.000 h	on/off >15.000
<b>22W</b>	IP 20 IK 02	2000 lumen	140°	165-265V 50Hz	CRI(RA) >80	PF >0.5	30.000 h	on/off >15.000

Watt	4W	9W	14W	18W	22W
Lumen	400	800	1000	1200	2000
Voltage	165-265V	165-265V	165-265V	165-265V	165-265V
CRI	>80	>80	>80	>80	>80
Γωνία δέσμης	140°	140°	140°	140°	140°
Θερμοκρασία	3000/4000/6000K	3000/4000/6000K	3000/4000/6000K	3000/4000/6000K	3000/4000/6000K
Διάρκεια ζωής	30 000 H	30 000 H	30 000 H	30 000 H	30 000 H
ON/OFF					
Μέγεθος λάμπας	30cm	60cm	90cm	120cm	150cm

ΚΩΔ.

20.09.1371

20.09.1372

20.09.1373

20.09.1374

20.09.1375



**ΕΠΑΝΑΦΟΡΤΙΖΟΜΕΝΟΙ ΦΑΝΟΙ LED**



ΚΩΔΙΚΟΣ	LED	Lumen	Διαστάσεις(mm)	Συσκ.
20.99.9011	30	180	220x60x28	20
20.99.9012	60	200	220x60x28	20



30-60 LED



6500K



6 Ώρες  
Αυτονομία Max



Προστασία  
(από υπερφόρτιση  
& εκφόρτιση)



Επαναφορτιζόμενη  
Μπαταρία  
Li-Ion 3,7V/1,6Ah



Αυτόματη  
ενεργοποίηση

20.99.9011

Υψηλής ποιότητας & ακόμα  
μεγαλύτερης φωτεινότητας!



20.99.9012



- Με Επαναφορτιζόμενη Μπαταρία LI-ION (Λιθίου) 3,7V/1,6Ah, μακράς διάρκειας
- Αυτονομία: έως **6½ ώρες** (στις 3½ πρώτες ώρες με πλήρη φωτεινότητα)
- Φωτεινότητα έως 180lm/200lm
- Προστασία από υπερφόρτιση & εκφόρτιση μπαταρίας
- Πλήκτρο για έλεγχο λειτουργίας
- Ένδειξη LED για φόρτιση μπαταρίας & 2 κλίμακες επιλογής φωτεινότητας
- Επεκτεινόμενα σημεία στερέωσης
- Καλώδιο διπολικό για 230VAC/2W
- Βαθμός Προστασίας: IP20

**ΕΠΑΝΑΦΟΡΤΙΖΟΜΕΝΟΣ ΦΑΝΟΣ LED  
ΜΕ 2 ΠΡΟΒΟΛΕΙΣ**



ΚΩΔΙΚΟΣ	Lumen	Συσκ.
20.99.9015	1 Προβ.: 500	10
	2 Προβ.: 1000	

- Επιλογή χρήσης ενός (1) ή δυο (2) προβολέων
- Με πλήκτρο για έλεγχο λειτουργίας
- Ένδειξη LED για φόρτιση μπαταρίας
- Με Επαναφορτιζόμενη Μπαταρία LI-ION (Λιθίου) 14,8V-1,2Ah μακράς διάρκειας
- Αυτονομία : έως **6 ώρες** (με 1 προβολέα) & **3 ώρες** (2 προβολείς)
- Φωτεινότητα έως 1000lm (2 προβολείς) ή 500lm (1 προβολέα)
- Προστασία από υπερφόρτιση & εκφόρτιση μπαταρίας
- Δείκτης Προστασίας IP20



1000lm



6 Ώρες  
Αυτονομία Max



Επαναφορτιζόμενη  
Μπαταρία  
Li-Ion 14,8V/1,2Ah



Αυτόματη  
ενεργοποίηση



# CINCA 60L - LED

## ΕΥΡΩΠΑΪΚΟ ΦΩΤΙΣΤΙΚΟ ΑΣΦΑΛΕΙΑΣ



ΚΩΔΙΚΟΣ	LED	Lumen	Αυτονομία	Συσκ.
20.09.1325	4	80	60' / 90'	24



Καλύπτουν όλες τις Ευρωπαϊκές Προδιαγραφές & Πιστοποιήσεις

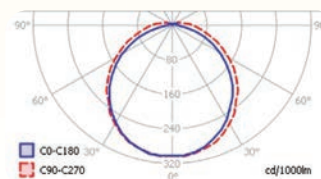
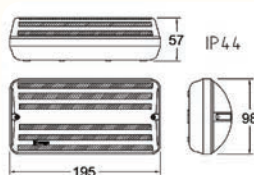

- Παρόμοια φωτεινότητα με λιγότερη κατανάλωση & σε μικρότερο μέγεθος από φωτιστικά των 6W
- Αυτονομία 90' min 60' για τα επόμενα 4 χρόνια
- Ματ γαλακτώδες πλαστικό κάλυμμα (αντί διαφανούς) για καλύτερη αισθητική
- Θερμοκρασίες: 5300 - 6500K
- Φόρτιση Μπαταρίας: 24 Ώρες
- Βαθμός προστασίας: IP44, IK07
- Διαστάσεις: 195x98x57mm - Βάρος: 318gr
- Τροφοδοσία: 1,4W - 220-240V/ 50-60Hz

## ΠΡΟΒΟΛΕΙΣ LED



10W → 60W	IP 65 IK 05	PF >0.7	50W → 300W	IP 65 IK 05	PF >0.9
20W → 120W	IP 65 IK 05	PF >0.7	100W → 600W	IP 65 IK 05	PF >0.9
30W → 180W	IP 65 IK 05	PF >0.9	150W → 900W	IP 65 IK 05	PF >0.5/ >0.9



Watt	10W	20W	30W	50W	100W	150W
Lumen	1000	2000	3000	5000	10 000	9 000
Voltage	220 - 240 V	220 - 240 V	220 - 240 V	220 - 240 V	220 - 240 V	180-265 V
CRI	>70	>70	>70	>70	>70	>70
Γωνία δέσμης	120°	120°	120°	120°	120°	110°
Θερμοκρασία	4000 / 6000K	4000 / 6000K	4000 / 6000K	4000 / 6000K	4000 / 6000K	4000 / 6500K
Διάρκεια ζωής	25 000 H	25 000 H	25 000 H	25 000 H	25 000 H	30 000 H
ON/OFF	> 15 000	> 15 000	> 15 000	> 15 000	> 15 000	
Μέγεθος λάμπας	75x81x21,5mm	103x99x23,5mm	125x119x25mm	165x160x35mm	255x213x33mm	

ΚΩΔ.	20.61.0401	20.61.0402	20.61.0404	20.61.0405	20.61.0406	20.61.0407	20.61.0408	20.61.0409	20.61.0410	20.61.0411	20.08.1296	20.08.1296N
Μοντέλο	HFL110C	HFL110N	HFL120C	HFL120N	HFL130C	HFL130N	HFL150C	HFL150N	HFL910C	HFL910N		
	20.08.1291W	20.08.1292W	20.08.1293W	20.08.1294W	20.08.1295W							

## ΠΡΟΒΟΛΕΙΣ LED ΜΕ ΑΙΣΘΗΤΗΡΑ ΚΙΝΗΣΗΣ



10W → 60W	IP 65 IK 05	PF >0.5	30W → 180W	IP 65 IK 05	PF >0.5	PIR Sensor
20W → 120W	IP 44 IK 05	PF >0.7	50W → 300W	IP 65 IK 05	PF >0.9	

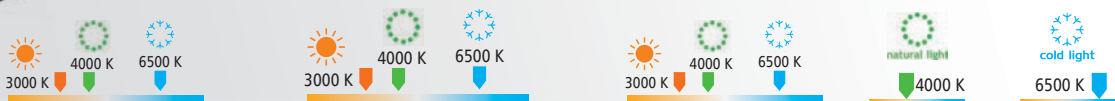

Watt	10W	20W	20W	30W	50W	50W
Lumen	900/ 800	2000	2000	2700/ 2400	5000	5000
Voltage	180-265 V	220 - 240 V	220 - 240 V	180-265 V	220 - 240 V	220 - 240 V
CRI	>70	>70	>70	>70	>70	>70
Γωνία δέσμης	110°	120°	120°	110°	120°	120°
Θερμοκρασία	3000/ 4200/ 6300K	4000 / 6000 K	3000 K	3000/ 4200/ 6300K	4000 K	6000 K
Διάρκεια ζωής	30 000 H	25 000 H	25 000 H	30 000 H	30 000 H	25 000 H
ON/OFF		> 15 000			> 15 000	> 15 000
Μέγεθος λάμπας		125x150x43mm			191x211x56mm	191x211x56mm

ΚΩΔ.	20.08.1281	20.08.1281N	20.61.0472	20.61.0471	20.08.1282W	20.08.1283	20.08.1283N	20.61.0474	20.61.0473
Μοντέλο	20.08.1281W		HFL120NS	HFL120CS		20.08.1283W		HFL150NS	HFL150CS

## ΠΡΟΒΟΛΕΙΣ ΠΛΑΤΙ LED

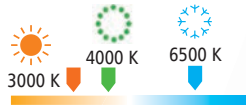

IP65
CRI(RA) >70
CRI(RA) >80
PF >0,9
120°
230V 50/60 Hz
Hg

25 000 h
>15 000
100% (<1s)

ΚΩΔ.	Μοντέλο	WATT	IP	Lumen	Beam	Volt	Color	CRI	COS φ	FAN	EEL	Size
20.63.0551	LFL101	10W	IP65	800lm	120°	220-240V	6000K	>70	>0,9	5907377256649	G	115x108x26mm
20.63.0552	LFL101N	10W	IP65	800lm	120°	220-240V	4000K	>70	>0,9	5901087201548	G	103x83x24mm
20.63.0553	LFL102	10W	IP65	800lm	120°	220-240V	3000K	>70	>0,9	5907377256656	G	115x108x26mm
20.63.0554	LFL103	20W	IP65	1500lm	120°	220-240V	6000K	>70	>0,9	5907377256663	G	153x132x27mm
20.63.0555	LFL103N	20W	IP65	1600lm	120°	220-240V	4000K	>70	>0,9	5901087201555	G	126x100x24mm
20.63.0556	LFL104	20W	IP65	1400lm	120°	220-240V	3000K	>70	>0,9	5907377256670	G	153x132x27mm
20.63.0557	LFL105	30W	IP65	2500lm	120°	220-240V	6000K	>70	>0,9	5907377256687	G	178x152x28mm
20.63.0558	LFL105N	30W	IP65	3000lm	120°	220-240V	4000K	>70	>0,9	5901087201562	F	178x152x28mm
20.63.0559	LFL106	30W	IP65	2400lm	120°	220-240V	3000K	>70	>0,9	5907377256694	G	178x152x28mm
20.63.0560	LFL107	50W	IP65	5000lm	120°	220-240V	6000K	>70	>0,9	5907377256700	F	223x188x28mm
20.63.0561	LFL107N	50W	IP65	4000lm	120°	220-240V	4000K	>70	>0,9	5901087201579	F	205x160x33.5mm
20.63.0562	LFL108	50W	IP65	4000lm	120°	220-240V	3000K	>70	>0,9	5907377256717	G	223x188x28mm
20.63.0563	LFL109	100W	IP65	10000lm	120°	220-240V	6000K	>70	>0,9	5907377256724	F	291x240x30mm
20.63.0565	LFL109N	100W	IP65	8000lm	120°	220-240V	4000K	>70	>0,9	5901087201586	G	270x210x33.5mm
20.63.0566	LFL111	150W	IP65	15000lm	120°	220-240V	6000K	>70	>0,9	5907377256731	F	404x322x48mm
20.63.0567	LFL113	200W	IP65	20000lm	120°	220-240V	6000K	>70	>0,9	5907377252320	F	439x346x48mm
20.63.0568	LFL117	300W	IP65	30000lm	120°	220-240V	6000K	>70	>0,9	5907377252344	F	529x415x55mm

## ΠΡΟΒΟΛΕΙΣ ΠΛΑΤΙ LED ΜΕ ΑΙΣΘΗΤΗΡΑ ΚΙΝΗΣΗΣ



25 000 h

>15 000

100% (<1s)

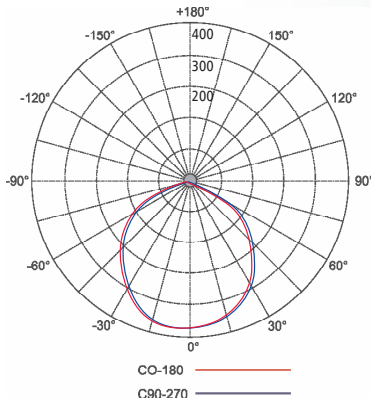

220-240V 50/60Hz
120°
CRI(RA) >80
IP44
F
Hg
PF >0,9

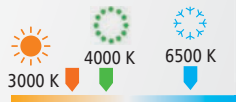

ΚΩΔ.	Μοντέλο	WATT	IP	Lumen	Beam	Volt	Color	CRI	COS φ	FAN	EEL	Size
20.63.0702	LFL103S	20W	IP44	2000lm	120°	220-240V	6000K	>70	>0,9	5907377257646	F	153x132x27mm
20.63.0701	LFL103NS	20W	IP44	1600lm	120°	220-240V	4000K	>70	>0,9	5901087201593	G	126x100x24mm
20.63.0704	LFL104S	20W	IP44	1600lm	120°	220-240V	3000K	>70	>0,9	5907377257653	G	153x178x54mm
20.63.0706	LFL105S	30W	IP44	3000lm	120°	220-240V	6000K	>70	>0,9	5907377257660	F	178x198x55mm
20.63.0705	LFL105NS	30W	IP44	2400lm	120°	220-240V	4000K	>70	>0,9	5901087201609	G	159x122x26mm
20.63.0707	LFL106S	30W	IP44	2400lm	120°	220-240V	3000K	>70	>0,9	5907377257677	G	178x198x55mm
20.63.0709	LFL107S	50W	IP44	4000lm	120°	220-240V	6500K	>70	>0,9	5901087201623	G	205x160x33.5mm
20.63.0708	LFL107NS	50W	IP44	4000lm	120°	220-240V	4000K	>70	>0,9	5901087201616	G	205x160x33.5mm

## ΠΡΟΒΟΛΕΙΣ GALAXI LED

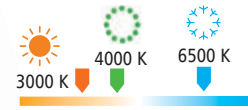

- 35 000 h
- >30 000
- 100% (<1s)
- 185-265V 50/60Hz
- 90°
- CRI(RA) >80
- IP65 IK08
- F
- Hg
- PF >0,9

ΚΩΔ.	Μοντέλο	WATT	IP	Lumen	Beam	Volt	Color	CRI	COS Φ	FAN	EEL	Size
20.63.0569	LFL210	10W	IP65	1000lm	90°	AC185-265	4000K	>80	>0.9	5901087207779	F	107x84x16mm
20.63.0570	LFL211	10W	IP65	1000lm	90°	AC185-265	6000K	>80	>0.9	5901087207786	F	107x84x16mm
20.63.0571	LFL220	20W	IP65	2000lm	90°	AC185-265	4000K	>80	>0.9	5901087207793	F	141x100x19mm
20.63.0572	LFL221	20W	IP65	2000lm	90°	AC185-265	6000K	>80	>0.9	5901087207809	F	141x100x19mm
20.63.0573	LFL230	30W	IP65	3000lm	90°	AC185-265	4000K	>80	>0.9	5901087207816	F	177x128x19mm
20.63.0574	LFL231	30W	IP65	3000lm	90°	AC185-265	6000K	>80	>0.9	5901087207823	F	177x128x19mm
20.63.0575	LFL250	50W	IP65	5000lm	90°	AC185-265	4000K	>80	>0.9	5901087207830	F	223x164x19mm
20.63.0576	LFL251	50W	IP65	5000lm	90°	AC185-265	6000K	>80	>0.9	5901087207847	F	223x164x19mm
20.63.0577	LFL260	100W	IP65	10000lm	90°	AC185-265	4000K	>80	>0.9	5901087207854	F	277x210x30mm
20.63.0578	LFL261	100W	IP65	10000lm	90°	AC185-265	6000K	>80	>0.9	5901087207861	F	277x210x30mm
20.63.0579	LFL270	150W	IP65	15000lm	90°	AC185-265	4000K	>80	>0.9	5901087207878	F	340x248x39mm
20.63.0580	LFL271	150W	IP65	15000lm	90°	AC185-265	6000K	>80	>0.9	5901087207885	F	340x248x39mm
20.63.0581	LFL280	200W	IP65	20000lm	90°	AC185-265	4000K	>80	>0.9	5901087207892	F	393x280x42mm
20.63.0582	LFL281	200W	IP65	20000lm	90°	AC185-265	6000K	>80	>0.9	5901087207908	F	393x280x42mm

## ΠΡΟΒΟΛΕΙΣ GALAXI LED ΜΕ ΑΙΣΘΗΤΗΡΑ ΚΙΝΗΣΗΣ

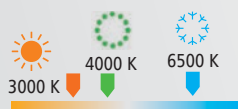
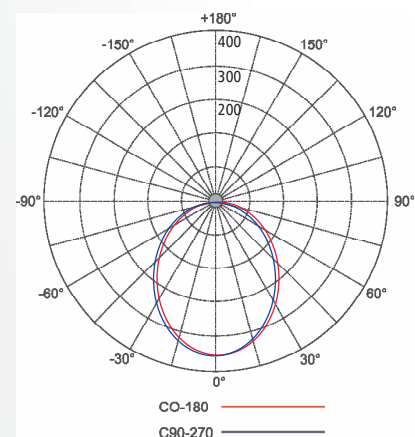

- 185-265V 50/60Hz
- 90°
- CRI(RA) >80
- IP44
- F
- Hg
- PF >0,9

ΚΩΔ.	Μοντέλο	WATT	IP	Lumen	Beam	Volt	Color	CRI	COS Φ	FAN	EEL	Size
20.63.0710	LFL220S	20W	IP44	2000	90°	AC185-265	4000K	>80	>0.9	5901087207915	F	177x180x54mm
20.63.0711	LFL221S	20W	IP44	2000	90°	AC185-265	6000K	>80	>0.9	5901087207922	F	177x180x54mm
20.63.0712	LFL250S	50W	IP44	5000	90°	AC185-265	4000K	>80	>0.9	5901087207939	F	223x215x54mm
20.63.0713	LFL251S	50W	IP44	5000	90°	AC185-265	6000K	>80	>0.9	5901087207946	F	223x215x54mm

## ΠΡΟΒΟΛΕΙΣ SOLAR LED



**max 980 lm** 2x(3,2Vx10Ah)  
Ισοδύναμο με **60W** κλασικού προβολέα

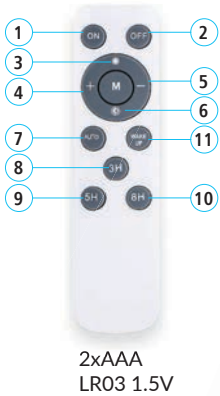

### ΤΗΛΕΧΕΙΡΙΣΤΗΡΙΟ

1. Κουμπί ON
2. Κουμπί OFF
3. 100% φωτισμός
4. Αυξήση φωτεινότητας
5. Μείωση φωτεινότητας
6. 50% φωτισμός
7. Κουμπί AUTO: Ενεργοποιείται αυτόματα τη νύχτα με έλεγχο φωτός.
8. Κουμπί 3H. Ενεργοποιήστε αφού νυχτώσει, κλείνει αυτόματα μετά από 3 ώρες.
9. Κουμπί 5H. Ενεργοποιήστε αφού νυχτώσει, κλείνει αυτόματα μετά από 5 ώρες.
10. Κουμπί 8H. Ενεργοποιήστε αφού νυχτώσει, κλείνει αυτόματα μετά από 8 ώρες.
11. Πατήστε αυτό το πλήκτρο πριν από την πρώτη χρήση.

2xAAA  
LR03 1.5V

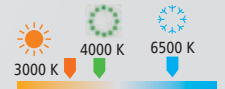

50 000 h | >100 000 | 100% (<1s) | IP 65 | IK 08 | lumen 980 Fixture | replace 60W LED lamp | 90° | CRI(RA) >70 | Kelvin 6000 | Kelvin 4000 | F | Hg

ΚΩΔ.	Μοντέλο	IP	Lumen	Beam	Temp	CRI	FAN	panel	floodlight
20.65.0002	LFS60TK02N	65	980lm	90°	4000K	>70	-	350x350x17mm	200x180x41mm
20.65.0001	LFS60TK02	65	980lm	90°	6000K	>70	5901087205768	350x350x17mm	200x180x41mm

## ΦΩΤΙΣΤΙΚΟ ΣΤΗΛΟΥ SOLAR RX LED

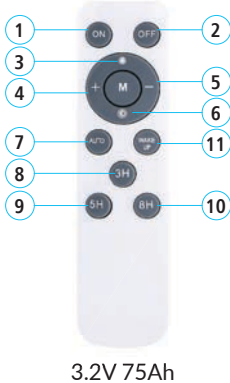

### ΤΗΛΕΧΕΙΡΙΣΤΗΡΙΟ

1. Κουμπί ON
2. Κουμπί OFF
3. 100% φωτισμός
4. Αυξήση φωτεινότητας
5. Μείωση φωτεινότητας
6. 50% φωτισμός
7. Κουμπί AUTO: Ενεργοποιείται αυτόματα τη νύχτα με έλεγχο φωτός.
8. Κουμπί 3H. Ενεργοποιήστε αφού νυχτώσει, κλείνει αυτόματα μετά από 3 ώρες.
9. Κουμπί 5H. Ενεργοποιήστε αφού νυχτώσει, κλείνει αυτόματα μετά από 5 ώρες.
10. Κουμπί 8H. Ενεργοποιήστε αφού νυχτώσει, κλείνει αυτόματα μετά από 8 ώρες.
11. Πατήστε αυτό το πλήκτρο πριν από την πρώτη χρήση.

3.2V 75Ah

3000 K | 4000 K | 6500 K | IP 65 | IK 08 | F | Hg | 130x90° | CRI(RA) >80 | 50 000 h | >100 000 | 100% (<1s)

ΚΩΔ.	Μοντέλο	IP	Lumen	Beam	Temp	CRI	battery	panel	lamp
20.64.0802	LUS100RXN	65	2000lm	130x90°	4000K	>80	3,2V 25Ah	350x810x25mm	409x165x54mm
20.64.0801	LUS100RX	65	2000lm	130x90°	6000K	>80	3,2V 25Ah	350x810x25mm	409x165x54mm
20.64.0804	LUS200RXN	65	4000lm	130x90°	4000K	>80	3,2V 75Ah	600x670x30mm	498x201x73mm
20.64.0803	LUS200RX	65	4000lm	130x90°	6000K	>80	3,2V 75Ah	600x670x30mm	498x201x73mm
20.64.0806	LUS300RXN	65	5300lm	130x90°	4000K	>80	12V 40Ah	600x1300x35mm	571x246x75mm
20.64.0805	LUS300RX	65	5300lm	130x90°	6000K	>80	12V 40Ah	600x1300x35mm	571x246x75mm



- 35 000 h
- Ώρες φόρτισης 5-6h
- 100% (<1s)
- 

- Ώρες Λειτουργίας: 4-12 ώρες
- Ώρες Φόρτισης: 5-6 ώρες
- USB Φόρτιση:



High 100%    Medium 60%    Low 20%    SOS flashing

**LFP030 900lm**



- IP 65
- IK 08
- lumen 900
- 6500 Kelvin
- 5V
- 90°
- CRI(RA) >80

**LFP050 1700lm**



- IP 65
- IK 08
- lumen 1700
- 6500 Kelvin
- 5V
- 90°
- CRI(RA) >80

ΚΩΔ.	Μοντέλο	IP	Lumen	Beam	Temp	Volt	CRI	FAN	Size
20.63.0602	LFP030	65	900lm	90°	6500K	3,7V 1000mAh	>80	5901087211325	219x279x56mm
20.63.0603	LFP050	65	1700lm	90°	6500K	3,7V 1000mAh	>80	5901087211332	244x324x59mm

## ΠΡΟΒΟΛΕΑΣ LUMI LED

OPTIONAL  
**5 years**  
Guarantee

**160lm/W**

cold light 6500 K 4000 K natural light

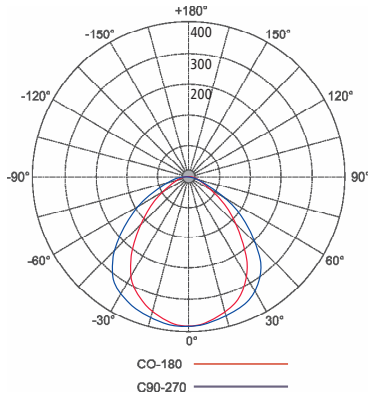

25 000 h >15 000 100% (<1s) IP65 CRI(RA) >70 PF >0,9 105° 220-240V 50/60 Hz Hg

ΚΩΔ.	Μοντέλο	WATT	IP	Lumen	Beam	Volt	Color	CRI	COS Φ Power Factor	EAN	EEI	Dimensions
20.63.0605	LFL302	30W	65	4800lm	105°	220-240V	4000K	>70	>0,9	5901087209094	C	204x165x46mm
20.63.0604	LFL303	30W	65	4800lm	105°	220-240V	6000K	>70	>0,9	5901087209100	C	204x165x46mm
20.63.0591	LFL305	50W	65	8000lm	105°	220-240V	4000K	>70	>0,9	5901087209117	C	241x197x46mm
20.63.0592	LFL306	50W	65	8000lm	105°	220-240V	6000K	>70	>0,9	5901087209124	C	241x197x46mm
20.63.0593	LFL308	100W	65	16000lm	105°	220-240V	4000K	>70	>0,9	5901087209131	C	299x247x49mm
20.63.0594	LFL309	100W	65	16000lm	105°	220-240V	6000K	>70	>0,9	5901087209148	C	299x247x49mm
20.63.0595	LFL311	150W	65	24000lm	105°	220-240V	4000K	>70	>0,9	5901087209155	C	390x318x55mm
20.63.0596	LFL312	150W	65	24000lm	105°	220-240V	6000K	>70	>0,9	5901087209162	C	390x318x55mm
20.63.0597	LFL314	200W	65	32000lm	105°	220-240V	4000K	>70	>0,9	5901087209179	C	458x371x57mm
20.63.0598	LFL315	200W	65	32000lm	105°	220-240V	6000K	>70	>0,9	5901087209186	C	458x371x57mm

## ΑΣΥΜΜΕΤΡΟΣ ΕΠΑΓΓΕΛΜΑΤΙΚΟΣ ΠΡΟΒΟΛΕΑΣ TRENTI LED

OPTIONAL  
**5 years**  
Guarantee

**170lm/W**

4000 K natural light

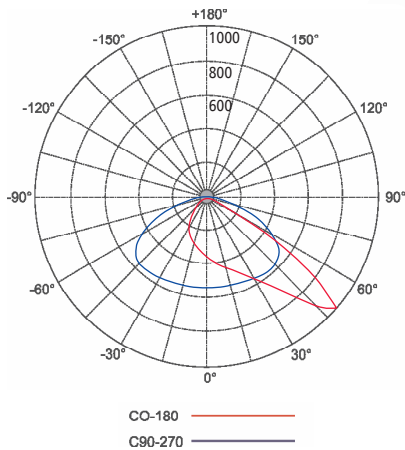

100 000 h >50 000 100% (<1s) IP66 IP65 CRI(RA) >70 PF >0,9 PF >0,97 110-45° 95-45° 220-240V 50/60 Hz Hg

ΚΩΔ.	Μοντέλο	WATT	IP	Lumen	Beam	Volt	Color	CRI	COS Φ Power Factor	FAN	EEI	Dimensions
20.63.0599	LFL351N	100W	66	17000lm	110x45°	100-277V	4000K	>70	>0,9	5901087210946	B	361x329x57mm
20.63.0600	LFL352	150W	65	25800lm	95x45°	120-277V	4000K	>70	>0,97	5901087209995	C	439x303x60mm
20.63.0601	LFL353	200W	65	35100lm	95x45°	120-277V	4000K	>70	>0,97	5901087210007	B	533x376x66mm

LED HIGH BAY



5700 K

Watt	100W	150W	200W
Lumen	12 000	18 000	24 000
Voltage	175-265 V	175-265 V	175-265 V
CRI	>70	>70	>70
Γωνία δέσμης	120°	120°	120°
Θερμοκρασία	5700 K	5700 K	5700 K
Διάρκεια ζωής	50 000 H	50 000 H	50 000 H
ON/OFF	> 15 000	> 15 000	> 15 000
Μέγεθος λάμπας	ø 230 x 81 mm	ø 260 x 81 mm	ø 310 x 81 mm

ΚΩΔ.

20.61.0501

20.61.0502

20.61.0503

Μοντέλο

HHB100

HHB150

HHB200

100W	IP 65 IK 08	12000 lumen	120°	175-265V 50-60 Hz	CRI(RA) >70	PF >0.9	50.000 h	on/off >15 000	100% w<1s
150W	IP 65 IK 08	18000 lumen	120°	175-265V 50-60 Hz	CRI(RA) >70	PF >0.9	50.000 h	on/off >15 000	100% w<1s
200W	IP 65 IK 08	24000 lumen	120°	175-265V 50-60 Hz	CRI(RA) >70	PF >0.9	50.000 h	on/off >15 000	100% w<1s

ΠΡΟΒΟΛΕΑΣ ΡΑΓΑΣ LED



4000 K



Watt	10W
Lumen	800
Voltage	220-240 V
CRI	>80
Γωνία δέσμης	60°
Θερμοκρασία	4000 K
Διάρκεια ζωής	25 000 H
Μέγεθος λάμπας	57x100 mm

ΚΩΔ.

20.61.0526

Μοντέλο

HTR1002

GU10 LED πηγή φωτισμού

10W	IP 20 IK 06	800 lumen	60°	220-240V 50-60 Hz	CRI(RA) >80	PF >0.5	25.000 h	GU10	100% w<1s
-----	----------------	--------------	-----	-------------------------	----------------	------------	----------	------	--------------



## ΠΑΝΕΛ ΦΩΤΙΣΜΟΥ LED 60x60 / ΕΠΙΦΑΝΕΙΑΚΗΣ ΤΟΠΟΘΕΤΗΣΗΣ

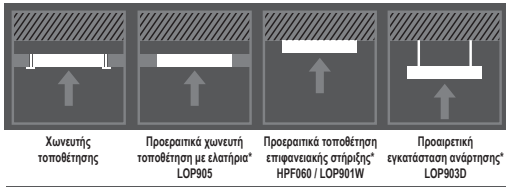

\*απαιτείται πρόσθετο σετ στερέωσης



	4000 K	6500 K	4000 K
Watt	40W E	40W EC	40W ESM
Lumen	4400	4400	4400
Voltage	175-265V	175-265V	175-265V
CRI	>80	>80	>80
Γωνία δέσμης	120°	120°	120°
Θερμοκρασία	4000 K	6500 K	4000 K
Διάρκεια ζωής	30 000 H	30 000 H	30 000 H
ON/OFF	> 15 000	> 15 000	> 15 000
Μέγεθος λάμπας	595x595x8mm	595x595x8mm	595x595x35mm

<b>ΚΩΔ.</b>	<b>20.61.0753</b>	<b>20.61.0754</b>	<b>20.61.0755</b>
<b>Μοντέλο</b>	<b>HPL4060E</b>	<b>HPL4060EC</b>	<b>HPL4060ESM</b>

Προαιρετικό εξάρτημα επιφανειακής τοποθέτησης για LED πάνελ 60x60

**ΚΩΔ.** 20.66.0005 **Μοντέλο** LOP901W

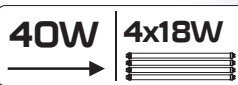

## ΠΑΝΕΛ ΦΩΤΙΣΜΟΥ LED BACKLITE 60x60



Driver τάσης εντός του φωτιστικού



\*απαιτείται πρόσθετο σετ στερέωσης

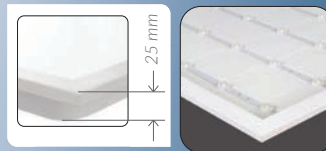

	4000 K
Watt	40W
Lumen	4400
Voltage	185-265V
CRI	>80
Γωνία δέσμης	120°
Θερμοκρασία	4000 K
Διάρκεια ζωής	35 000 H
ON/OFF	> 20 000
Μέγεθος λάμπας	595x595x25mm
<b>ΚΩΔ.</b>	<b>20.61.0752</b>
<b>Μοντέλο</b>	<b>HPB4060UGR</b>

Προαιρετικό εξάρτημα επιφανειακής τοποθέτησης για LED πάνελ 60x60

**ΚΩΔ.** 20.66.0005 **Μοντέλο** LOP901W

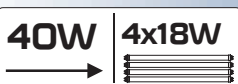

ΦΩΤΙΣΤΙΚΟ ΟΡΟΦΗΣ LED



4000 K 6500 K 4000 K 6500 K

Watt	15W	15W	30W	30W
Lumen	1500	1500	3200	3200
Voltage	220-240 V	220-240 V	220-240 V	220-240 V
CRI	>80	>80	>80	>80
Γωνία δέσμης	110°	110°	110°	110°
Θερμοκρασία	4000 K	6500 K	4000 K	6500 K
Διάρκεια ζωής	25 000 H	25 000 H	25 000 H	25 000 H
Μέγεθος λάμπας	580x76x25mm	580x76x25mm	1180x76x25mm	1180x76x25mm
ΚΩΔ.	20.61.0551	20.61.0552	20.61.0553	20.61.0554
Μοντέλο	HDS1502	HDS1503	HDS3002	HDS3003

15W	2x18W	IP 44	IK 06	1500 lumen	110°	220-240V 50-60 Hz	CRI(RA) >80	PF >0.5	25.000 h	100% w<1s
30W	2x36W	IP 44	IK 06	3200 lumen	110°	220-240V 50-60 Hz	CRI(RA) >80	PF >0.9	25.000 h	100% w<1s

ΣΤΕΓΑΝΟ ΦΩΤΙΣΤΙΚΟ LED



4000 K 4000 K

Watt	18W	36W
Lumen	1500	3000
Voltage	170 - 265 V	170 - 265 V
CRI	>80	>80
Γωνία δέσμης	120°	120°
Θερμοκρασία	4000 K	4000 K
Διάρκεια ζωής	30 000 H	30 000 H
ON/OFF	> 15 000	> 15 000
Μέγεθος λάμπας	600x53x29mm	1175x53x29mm
ΚΩΔ.	20.61.0555	20.61.0556
Μοντέλο	HTP018N	HTP036N

18W	2x18W	IP 65	IK 08	1500 lumen	120°	170-265V 50-60 Hz	CRI(RA) >80	PF >0.9	30.000 h	on/off >15.000	100% w<1s
36W	2x36W	IP 65	IK 08	3000 lumen	120°	170-265V 50-60 Hz	CRI(RA) >80	PF >0.9	30.000 h	on/off >15.000	100% w<1s

## ΣΤΕΓΑΝΟ ΦΩΤΙΣΤΙΚΟ LED



<b>15W</b>	<b>2x18W</b>	<b>IP 65</b>		<b>1500 lumen</b>		<b>220-240V</b>	<b>50-60 Hz</b>	<b>CRI(RA) &gt;80</b>	<b>PF &gt;0.5</b>		<b>100% w&lt;1s</b>
		<b>IK 06</b>		<b>130°</b>						<b>30.000 h</b>	
<b>30W</b>	<b>2x36W</b>	<b>IP 65</b>		<b>3200 lumen</b>		<b>220-240V</b>	<b>50-60 Hz</b>	<b>CRI(RA) &gt;80</b>	<b>PF &gt;0.9</b>		<b>100% w&lt;1s</b>
		<b>IK 06</b>		<b>130°</b>						<b>30.000 h</b>	
<b>45W</b>	<b>2x58W</b>	<b>IP 65</b>		<b>4850 lumen</b>		<b>220-240V</b>	<b>50-60 Hz</b>	<b>CRI(RA) &gt;80</b>	<b>PF &gt;0.9</b>		<b>100% w&lt;1s</b>
		<b>IK 06</b>		<b>130°</b>						<b>30.000 h</b>	



4000 K			6500 K	4000 K			6500 K	4000 K			6500 K
--------	--	--	--------	--------	--	--	--------	--------	--	--	--------

<b>Watt</b>	15W	15W	30W	30W	45W	45W
<b>Lumen</b>	1500	1500	3200	3200	4850	4850
<b>Voltage</b>	220-240 V	220-240 V	220-240 V	220-240 V	220-240 V	220-240 V
<b>CRI</b>	>80	>80	>80	>80	>80	>80
<b>Γωνία δέσμης</b>	130°	130°	130°	130°	130°	130°
<b>Θερμοκρασία</b>	4000 K	6500 K	4000 K	6500 K	4000 K	6500 K
<b>Διάρκεια ζωής</b>	30 000 H	30 000 H	30 000 H	30 000 H	30 000 H	30 000 H
<b>Μέγεθος λάμπας</b>	550x53x37mm	550x53x37mm	1150x53x37mm	1150x53x37mm	1150x68x43mm	1150x68x43mm

<b>ΚΩΔ.</b>	20.61.0557	20.61.0558	20.61.0559	20.61.0560	20.61.0561	20.61.0562
<b>Μοντέλο</b>	HTP1502	HTP1503	HTP3002	HTP3003	HTP4502	HTP4503



## ΣΥΝΔΕΟΜΕΝΟ ΣΤΕΓΑΝΟ ΦΩΤΙΣΤΙΚΟ LED



<b>30W</b>	<b>2x36W</b>	<b>IP 65</b>		<b>3200 lumen</b>		<b>220-240V</b>	<b>50-60 Hz</b>	<b>CRI(RA) &gt;80</b>	<b>PF &gt;0.9</b>		<b>100% w&lt;1s</b>	<b>12 PCS IN LINE</b>
		<b>IK 06</b>		<b>130°</b>						<b>30.000 h</b>		
<b>45W</b>	<b>2x58W</b>	<b>IP 65</b>		<b>4850 lumen</b>		<b>220-240V</b>	<b>50-60 Hz</b>	<b>CRI(RA) &gt;80</b>	<b>PF &gt;0.9</b>		<b>100% w&lt;1s</b>	<b>9 PCS IN LINE</b>
		<b>IK 06</b>		<b>130°</b>						<b>30.000 h</b>		
<b>60W</b>	<b>2x58W</b>	<b>IP 65</b>		<b>6500 lumen</b>		<b>220-240V</b>	<b>50-60 Hz</b>	<b>CRI(RA) &gt;80</b>	<b>PF &gt;0.9</b>		<b>100% w&lt;1s</b>	<b>6 PCS IN LINE</b>
		<b>IK 06</b>		<b>130°</b>						<b>30.000 h</b>		



### Συνδεδεμένο



4000 K			6500 K	4000 K			6500 K	4000 K			6500 K
--------	--	--	--------	--------	--	--	--------	--------	--	--	--------

<b>Watt</b>	30W	30W	45W	45W	60W	60W
<b>Lumen</b>	3200	3200	4850	4850	6500	6500
<b>Voltage</b>	220-240 V	220-240 V	220-240 V	220-240 V	220-240 V	220-240 V
<b>CRI</b>	>80	>80	>80	>80	>80	>80
<b>Γωνία δέσμης</b>	130°	130°	130°	130°	130°	130°
<b>Θερμοκρασία</b>	4000 K	6500 K	4000 K	6500 K	4000 K	6500 K
<b>Διάρκεια ζωής</b>	30 000 H	30 000 H	30 000 H	30 000 H	30 000 H	30 000 H
<b>Μέγεθος λάμπας</b>	1190x53x57mm	1190x53x57mm	1190x68x43mm	1190x68x43mm	1490x68x43mm	1490x68x43mm

<b>ΚΩΔ.</b>	20.61.0563	20.61.0564	20.61.0565	20.61.0566	20.61.0567	20.61.0568
<b>Μοντέλο</b>	HTP3002L	HTP3003L	HTP4502L	HTP4503L	HTP6002L	HTP6003L

LINEA - ΣΤΕΓΑΝΟ ΦΩΤΙΣΤΙΚΟ LED

**LUMAX**  
Bright side of life

IP65 | 90lm/W



- 25 000 h
- >15 000
- 100% (<1s)
- 

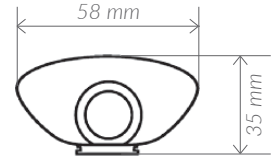

LHT051 18W

18W → 2x18W | IP 65 | IK 08 | lumen 1620 Fixture | 18W LED lamp | 170-265V 50/60 Hz | 120° | CRI(RA) >80 | Kelvin 4000 | F | Hg | PF >0,5

- 25 000 h
- >15 000
- 100% (<1s)
- 

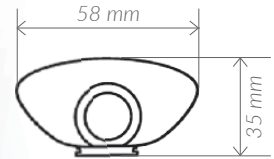

LHT092 36W

36W → 2x36W | IP 65 | IK 08 | lumen 3240 Fixture | 36W LED lamp | 170-265V 50/60 Hz | 120° | CRI(RA) >80 | Kelvin 4000 | F | Hg | PF >0,9

- 25 000 h
- >15 000
- 100% (<1s)
- 

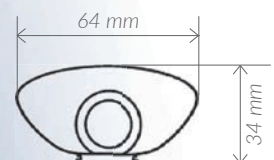

LHT064 60W

60W → ~120W | IP 65 | IK 08 | lumen 5400 Fixture | 60W LED lamp | 170-265V 50/60 Hz | 120° | CRI(RA) >80 | Kelvin 4000 | F | Hg | PF >0,9

- 25 000 h
- >15 000
- 100% (<1s)
- 

ΚΩΔ.	Μοντέλο	WATT	IP	Lumen	Beam	Volt	Color	CRI	Barcode	EEL	Dimensions
20.63.0856	LHT051	18W	65	1620lm	120°	170-265V	4000K	>80	5907377256410	F	602x58x35mm
20.63.0857	LHT092	36W	65	3240lm	120°	170-265V	4000K	>80	5901087208455	F	1162x58x35mm
20.63.0864	LHT064	60W	65	5400lm	120°	170-265V	4000K	>80	5901087200923	F	1275x64x34mm

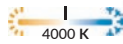
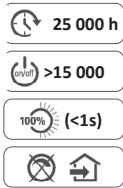
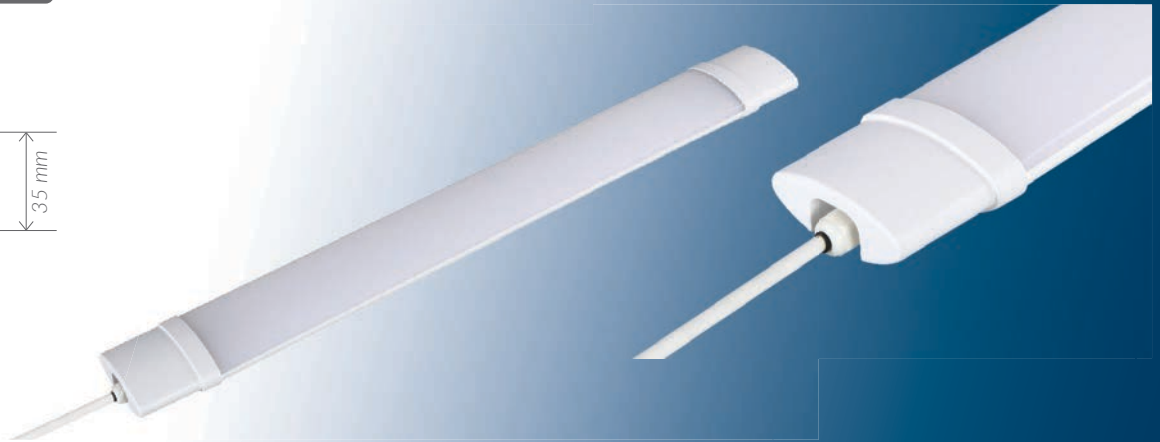
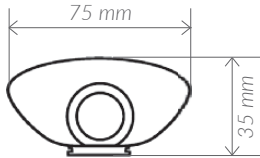
**LINEA - ΣΤΕΓΑΝΟ ΦΩΤΙΣΤΙΚΟ LED ΣΥΝΔΕΟΜΕΝΟ**
**IP65 | 90lm/W**

**LHT053 36W**

36W	~72W	IP 65	IK 08	lumen 3240 Fixture	36W LED lamp	170-265V 50/60 Hz	120°	CRI(RA) >80	Kelvin 4000	F	Hg	PF >0,9
-----	------	-------	-------	--------------------------	-----------------	-------------------------	------	----------------	----------------	---	----	------------

**LHT054 60W**

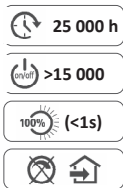
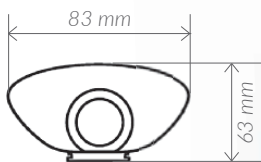
60W	~120W	IP 65	IK 08	lumen 5400 Fixture	60W LED lamp	170-265V 50/60 Hz	120°	CRI(RA) >80	Kelvin 4000	F	Hg	PF >0,9
-----	-------	-------	-------	--------------------------	-----------------	-------------------------	------	----------------	----------------	---	----	------------

**LHT055 80W**

80W	~160W	IP 65	IK 08	lumen 7200 Fixture	80W LED lamp	170-265V 50/60 Hz	120°	CRI(RA) >80	Kelvin 4000	F	Hg	PF >0,9
-----	-------	-------	-------	--------------------------	-----------------	-------------------------	------	----------------	----------------	---	----	------------

**LHT056 100W**

100W	~200W	IP 65	IK 08	lumen 9000 Fixture	100W LED lamp	170-265V 50/60 Hz	120°	CRI(RA) >80	Kelvin 4000	F	Hg	PF >0,9
------	-------	-------	-------	--------------------------	------------------	-------------------------	------	----------------	----------------	---	----	------------

ΚΩΔ.	Μοντέλο	WATT	IP	Lumen	Beam	Volt	Color	CRI	COSφ Power Factor	FAN	EEI	Dimensions
20.63.0858	LHT053	36W	65	3240lm	120°	170-265V	4000K	>80	>0,9	5907377257424	F	1160x75x35mm
20.63.0859	LHT054	60W	65	5400lm	120°	170-265V	4000K	>80	>0,9	5907377257431	F	1160x75x35mm
20.63.0860	LHT055	80W	65	7200lm	120°	170-265V	4000K	>80	>0,9	5907377255543	F	1135x83x63mm
20.63.0861	LHT056	100W	65	9000lm	120°	170-265V	4000K	>80	>0,9	5907377257455	F	1435x83x63mm

LINEA - ΣΤΕΓΑΝΟ ΦΩΤΙΣΤΙΚΟ LED

IP65 | 80lm/W



- 25 000 h
- >15 000
- 100% (<1s)
- 

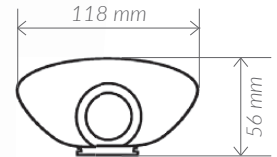

LHT057 140W

- 140W → ~250W
- IP 65 IK 08
- lumen 11200 Fixture
- 140W LED lamp
- 170-265V 50/60 Hz
- 120°
- CRI(RA) >80
- Kelvin 4000
- F
- Hg
- PF >0,9



- 25 000 h
- >15 000
- 100% (<1s)
- 

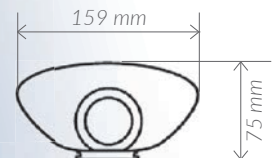

LHT058 180W

- 180W → ~320W
- IP 65 IK 08
- lumen 14400 Fixture
- 180W LED lamp
- 170-265V 50/60 Hz
- 120°
- CRI(RA) >80
- Kelvin 4000
- F
- Hg
- PF >0,9

ΚΩΔ.	Μοντέλο	WATT	IP	Lumen	Beam	Volt	Color	CRI	COSΦ	FAN	EEI	Dimensions
20.63.0862	LHT057	140W	65	11200lm	120°	170V-265V	4000K	>80	>0,9	5907377259565	G	1542x118x56mm
20.63.0863	LHT058	180W	65	14400lm	120°	170V-265V	4000K	>80	>0,9	5907377259572	G	1302x159x75mm

**LINEA+ - ΣΤΕΓΑΝΟ ΦΩΤΙΣΤΙΚΟ LED ΣΥΝΔΕΟΜΕΝΟ**
**IP65 | 105 lm/W**
**OPTIONAL  
5 years  
Guarantee**
**50 000 h**
**>25 000**
**100% (<1s)**

**LHT100HE 36W**

<b>36W</b>	<b>2x36W</b>	<b>IP 65</b>		<b>3800 lumen</b>	<b>36W LED lamp</b>	<b>220-240V 50/60 Hz</b>		<b>CRI(RA) &gt;80</b>	<b>Kelvin 4100</b>			<b>PF &gt;0,9</b>
		<b>IK 08</b>		<b>Fixture</b>	<b>LED lamp</b>	<b>Hz</b>	<b>120°</b>					

**Βασική έκδοση**

**Έκδοση για διασύνδεση**

ΚΩΔ.	Μοντέλο	WATT	IP	Lumen	Beam angle	Volt	Color	CRI	EAN	EEI	Dimensions
20.63.0865	LHT100HE	36W	65	3800lm	120°	220V-240V	4100K	>80	5901087200725	F	1210x50x49mm

ΦΩΤΙΣΤΙΚΟ ΟΡΟΦΗΣ LED



4000 K natural light 4000 K natural light 4000 K natural light

Watt	12W	18W	24W
Lumen	840	1820	1680
Voltage	220-240 V	220-240 V	220-240 V
CRI	>80	>80	>80
Γωνία δέσμης	120°	120°	120°
Θερμοκρασία	4000 K	4000 K	4000 K
Διάρκεια ζωής	25 000 H	25 000 H	25 000 H
ON/OFF	> 15 000	> 15 000	> 15 000
Μέγεθος λάμπας	ø260 x 45 mm	ø310 x 55 mm	ø350 x 55 mm
ΚΩΔ.	20.61.0853	20.61.0863	20.61.0858
Μοντέλο	HCL1204	HCL1804/R	HCL2404

IP 44	12W → 90W 30W	840 lumen	120°	220-240V 50-60 Hz	CRI(RA) >80	PF >0.5	25.000 h	on/off >15.000	100% w<1s
IP 44	18W → 125W 45W	1260 lumen	120°	220-240V 50-60 Hz	CRI(RA) >80	PF >0.5	25.000 h	on/off >15.000	100% w<1s
IP 44	24W → 180W 60W	1680 lumen	120°	220-240V 50-60 Hz	CRI(RA) >80	PF >0.5	25.000 h	on/off >15.000	100% w<1s

ΦΩΤΙΣΤΙΚΟ ΟΡΟΦΗΣ LED ΜΕ ΑΙΣΘΗΤΗΡΑ ΜΙΚΡΟΚΥΜΑΤΩΝ



4000 K natural light 4000 K natural light 4000 K natural light

Watt	12W	18W	18W
Lumen	840	1260	1260
Voltage	220-240 V	220-240 V	220-240 V
CRI	>80	>80	>80
Γωνία δέσμης	120°	120°	120°
Θερμοκρασία	4000 K	4000 K	4000 K
Διάρκεια ζωής	25 000 H	25 000 H	25 000 H
ON/OFF	> 15 000	> 15 000	> 15 000
Μέγεθος λάμπας	ø330 x 70 mm	ø330 x 70 mm	ø300 x 62 mm
ΚΩΔ.	20.61.0854	20.61.0857	20.61.0855
Μοντέλο	HCL1204S	HCL1804S	HCL1802IP



IP 44	12W → 90W 30W	840 lumen	120°	220-240V 50-60 Hz	CRI(RA) >80	PF >0.5	20.000 h	on/off >15.000	100% w<1s
IP 44	18W → 125W 45W	1260 lumen	120°	220-240V 50-60 Hz	CRI(RA) >80	PF >0.5	20.000 h	on/off >15.000	100% w<1s
IP 54	18W → 125W 45W	1260 lumen	120°	220-240V 50-60 Hz	CRI(RA) >80	PF >0.5	20.000 h	on/off >15.000	100% w<1s



**ΦΩΤΙΣΤΙΚΟ ΟΡΟΦΗΣ ΕΞΩΤΕΡΙΚΟΥ ΧΩΡΟΥ VERA LED**

- 30 000 h
- >50 000
- 100% (<1s)
- 

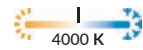
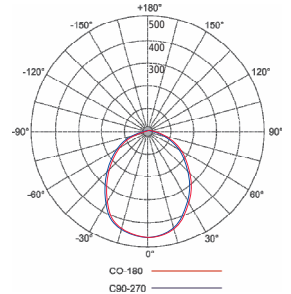
**OPTIONAL**  
5 years  
Guarantee

**LO1261 12W**

**12W** → **109W** **30W**   
**IP 65** **IK 06**   
**1160** **12W** **220-240V** **50/60** **Hz** **120°** **CRI(RA)** **>80** **Kelvin** **4000** **F** **Hg**

Με αισθητήρα μικροκυμάτων

**LO1261DS 12W**

**12W** → **109W** **30W**   
**IP 65** **IK 06**   
**840** **12W** **220-240V** **50/60** **Hz** **120°** **CRI(RA)** **>80** **Kelvin** **4000** **F** **Hg**



ΚΩΔ.	Μοντέλο	WATT	IP	Lumen	Beam	Volt	Color	CRI	COSφ	FAN	EEL	Size
20.64.0154	LO1261	12W	65	1160lm	120°	220-240V	4000K	>80	>0,5	5901087200770	F	ø 170x60mm
20.64.0303	LO1261DS	12W	65	840lm	120°	AC220-240V	4000K	>80	>0,5	5901087200787	G	ø 170x60mm

**ΠΛΑΦΟΝΙΕΡΑ ΕΞΩΤΕΡΙΚΟΥ ΧΩΡΟΥ LED**

**Watt** 15W  
**Lumen** 1200  
**Voltage** 220 - 240 V  
**CRI** >80  
**Γωνία δέσμης** 120°  
**Θερμοκρασία** 3000 K  
**Διάρκεια ζωής** 25 000 H  
**ON/OFF** > 15 000  
**Μέγεθος λάμπας** ø167 x 62mm  
**ΚΩΔ.** 20.61.0851  
**Μοντέλο** HBL1501

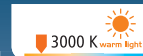

**Watt** 15W  
**Lumen** 1200  
**Voltage** 220 - 240 V  
**CRI** >80  
**Γωνία δέσμης** 120°  
**Θερμοκρασία** 3000 K  
**Διάρκεια ζωής** 25 000 H  
**ON/OFF** > 15 000  
**Μέγεθος λάμπας** 220x120x65mm  
**ΚΩΔ.** 20.61.0852  
**Μοντέλο** HBL1502

**15W** → **150W** **39W**   
**IP 65** **IK 08**

**1200** **120°** **220-240V** **50-60** **Hz** **CRI(RA)** **>80** **PF** **>0.5** **25.000 h** **on/off** **>15 000** **100% w<1s**

**15W** → **150W** **39W**   
**IP 65** **IK 08**

**1200** **120°** **220-240V** **50-60** **Hz** **CRI(RA)** **>80** **PF** **>0.5** **25.000 h** **on/off** **>15 000** **100% w<1s**

ΦΩΤΙΣΤΙΚΟ ΟΡΟΦΗΣ SPHERE III COMBO LED

Ρυθμιζόμενη θερμοκρασία χρώματος  
2 επιλογές ισχύος



12 / 18 W

OPTIONAL  
**5 years**  
Guarantee

30 000 h

>30 000

100% (<1s)



Επιφανειακής  
τοποθέτησης



Χωνευτής  
τοποθέτησης



LOR1805SM 12W/18W

12W → 44W	18W → 179W	IP44	3000 K	4000 K	6500 K
1200 lumen Fixture	1700 lumen Fixture	12W LED lamp	18W LED lamp	220-240V 50/60 Hz	110°
CRIR A)	Kelvin n	Kelvin n	Kelvin	F	Hg
>80	3000	4000	6000		



18 / 25 W

CCT διακόπτης για  
θερμοκρασία χρώματος



30 000 h

>30 000

100% (<1s)



Επιφανειακής  
τοποθέτησης



Χωνευτής  
τοποθέτησης

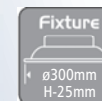
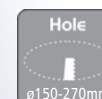

LOR2505SM 18W/25W

18W → 195W	25W → 243W	IP44	3000 K	4000 K	6500 K
1850 lumen Fixture	2300 lumen Fixture	18W LED lamp	25W LED lamp	220-240V 50/60 Hz	110°
CRIR A)	Kelvin n	Kelvin n	Kelvin	F	Hg
>80	3000	4000	6000		

ΚΩΔ.	Μοντέλο	WATT	IP	Lumen	Beam	Volt	Color	CRI	COSΦ	EEL	Size
20.64.0166	LOR1805SM	12W / 18W	44	1200lm / 1700lm	110°	220-240V AC	3000K / 4000K / 6000K	>80	>0,9	F	220x220x21.5mm
20.64.0167	LOR2505SM	18W / 25W	44	1850lm / 2300lm	110°	220-240V AC	3000K / 4000K / 6000K	>80	>0,9	F	ø 300x25mm

**ΦΩΤΙΣΤΙΚΟ ΟΡΟΦΗΣ SPHERE LED**

Προεραπικά διατίθεται με αισθητήρα παρουσίας  
& stand-by option 0%-20%-100%

25 000 h

>15 000

100% (<1s)



OPTIONAL  
**5 years**  
Guarantee



**LO1241NDS** 12W



IP 44 IK 04 lumen 650 Fixture 12W LED lamp 220-240V 50/60 Hz 120° CRI(RA) >80 Kelvin 4000 F Hg



**LO1221N** 12W



IP 20 IK 08

lumen 1200 Fixture 12W LED lamp 220-240V 50/60 Hz 120° CRI(RA) >80 Kelvin 4000 F Hg

**LO1821N** 18W



IP 20 IK 08

lumen 1820 Fixture 18W LED lamp 220-240V 50/60 Hz 120° CRI(RA) >80 Kelvin 4000 F Hg

**LO2421N** 24W



IP 20 IK 08

lumen 2500 Fixture 24W LED lamp 220-240V 50/60 Hz 120° CRI(RA) >80 Kelvin 4000 F Hg

**LO3621N** 36W



IP 20 IK 08

lumen 3820 Fixture 36W LED lamp 220-240V 50/60 Hz 120° CRI(RA) >80 Kelvin 4000 F Hg

ΚΩΔ.	Μοντέλο	WATT	IP	Lumen	Beam	Volt	Color	CRI	cosφ	EEI	Size
20.64.0302	LO1241NDS Αισθητήρας μικροκυμάτων	12W	44	650lm	120°	220-240V	4000K	>80	>0,9	G	ø 255x90mm
20.64.0151	LO1221N	12W	20	1200lm	120°	220-240V	4000K	>80	>0,5	F	ø 280x60mm
20.64.0159	LO1821N	18W	20	1820lm	120°	220-240V	4000K	>80	>0,5	F	ø 330x60mm
20.64.0162	LO2421N	24W	20	2500lm	120°	220-240V	4000K	>80	>0,5	F	ø 380x62mm
20.64.0163	LO3621N	36W	20	3820lm	120°	220-240V	4000K	>80	>0,9	F	ø 430x65mm

**ΦΩΤΙΣΤΙΚΟ ΟΡΟΦΗΣ AMBID I LED**



OPTIONAL  
**5 years**  
Guarantee

30 000 h

>50 000

100% (<1s)



4000 K natural light

15W → 150W 44W	IP 54 IK 06	lumen 1550 Fixture	15W LED lamp	220-240V 50/60 Hz	120°	CRI(RA) >80	Kelvin 4000	F	Hg
24W → 270W 72W	IP 54 IK 06	lumen 2500 Fixture	24W LED lamp	220-240V 50/60 Hz	120°	CRI(RA) >80	Kelvin 4000	F	Hg
15W → 150W 44W	IP 54 IK 06	lumen 1250 Fixture	15W LED lamp	100-240V 50/60 Hz	120°	CRI(RA) >80	Kelvin 4000	F	Hg
24W → 270W 72W	IP 54 IK 06	lumen 2050 Fixture	24W LED lamp	100-240V 50/60 Hz	120°	CRI(RA) >80	Kelvin 4000	F	Hg

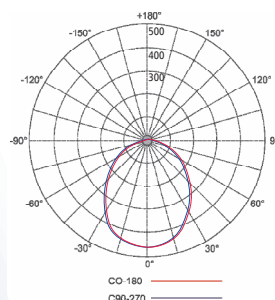

ΚΩΔ.	Μοντέλο	WATT	IP	Lumen	Beam	Volt	Color	CRI	COS Φ	FAN	EEI	Dimensions
20.64.0156	LO1541	15W	54	1550lm	120°	220-240V	4000K	>80	>0,5	5907377256021	F	ø 280x54mm
20.64.0164	LO2441	24W	54	2500lm	120°	220-240V	4000K	>80	>0,5	5907377256038	F	ø 280x54mm
20.64.0158	LO1542	15W	54	1250lm	120°	100-240V	4000K	>80	>0,9	5907377256069	G	220x220x54mm
20.64.0165	LO2442	24W	54	2050lm	120°	100-240V	4000K	>80	>0,9	5907377256076	F	280x280x54mm

**ΦΩΤΙΣΤΙΚΟ ΟΡΟΦΗΣ RING LED**



OPTIONAL  
**5 years**  
Guarantee

25 000 h

>25 000

100% (<1s)



4000 K natural light

IP20	lumen 1850 Light Source	lumen 1300 Fixture	18W LED lamp	220-240V 50/60 Hz	120°	CRI(RA) >80	Kelvin 4000	F	Hg	PF >0,5
IP44	lumen 1900 Light Source	lumen 1400 Fixture	20W LED lamp	220-240V 50/60 Hz	120°	CRI(RA) >80	Kelvin 4000	F	Hg	PF >0,5

**3 επίπεδα φωτεινότητας**  
Επιλεγόμενα από διακόπτη



ΚΩΔ.	Μοντέλο	WATT	IP	Lumen	Beam	Volt	Color	CRI	COS Φ	FAN	EEI	Dimensions
20.64.0160	LO1802B	18W	20	1300lm	120°	220-240V	4000K	>80	>0,5	5901087210885	-	ø 225x45mm
20.64.0161	LO2002W	20W	44	1400lm	120°	220-240V	4000K	>80	>0,5	5901087205843	G	ø 340x65mm

**ΧΩΝΕΥΤΑ ΣΠΟΤ**

Watt	8W => 50W	8W => 50W
Voltage	180-260V	180-260V
CRI	>80	>80
Γωνία δέσμης	25 000 H	25 000 H
ON/OFF	> 15 000	> 15 000
Μέγεθος λάμπας	ø78x52 mm	ø78x52 mm



Lumen	640	640
Γωνία δέσμης	60°	60°
Θερμοκρασία	4000 K	6500 K

ΚΩΔ.	20.61.0688	20.61.0687
Μοντέλο	HDW083MN	HDW083MC



Lumen	720	720
Γωνία δέσμης	100°	100°
Θερμοκρασία	4000 K	6500 K

ΚΩΔ.	20.61.0682	20.61.0681
Μοντέλο	HDW081WN	HDW081WC



**8W** | **50W** | **IP40** | **640 lumen** | **180-260V 50-60 Hz** | **CRI(RA) >80** | **PF >0.5** | **25.000 h** | **on/off >15 000** | **Hole < 65mm >**

Watt	8W => 50W	8W => 50W
Voltage	180-260V	180-260V
CRI	>80	>80
Γωνία δέσμης	25 000 H	25 000 H
ON/OFF	> 15 000	> 15 000
Μέγεθος λάμπας	ø74x52 mm	ø74x52 mm

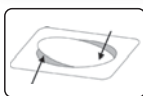

Lumen	640	640
Γωνία δέσμης	60°	60°
Θερμοκρασία	4000/6500K	4000/6500K



ΚΩΔ.	20.61.0690	20.61.0684
Μοντέλο	HDW084MN	HDW082MN
ΚΩΔ.	20.61.0689	20.61.0683
Μοντέλο	HDW084MC	HDW082MC



**8W** | **50W** | **IP40** | **640 lumen** | **180-260V 50-60 Hz** | **CRI(RA) >80** | **PF >0.5** | **25.000 h** | **on/off >15 000** | **Hole < 65mm >**

ΧΩΝΕΥΤΟ ΦΩΤΙΣΤΙΚΟ ΟΡΟΦΗΣ LED



HDWF17R 12W HDWF22R 18W

Προεραϊκά Εξαρτήματα Επιφανειακής Στήριξης

Watt	12W	12W	12W	18W	18W	18W
Lumen	800	850	900	1260	1820	1350
Voltage	180-260	180-260	180-260	180-260	180-260	180-260
CRI	>80	>80	>80	>80	>80	>80
Γωνία δέσμης	120°	120°	120°	120°	120°	120°
Θερμοκρασία	3000 K	4000 K	6500 K	3000 K	4000 K	6500 K
Διάρκεια ζωής	25 000 H	25 000 H	25 000 H	25 000 H	25 000 H	25 000 H
ON/OFF	> 15 000	> 15 000	> 15 000	> 15 000	> 15 000	> 15 000
Μέγεθος λάμπας	ø170x25,5mm	ø170x25,5mm	ø170x25,5mm	ø224x25,5mm	ø224x25,5mm	ø224x25,5mm
ΚΩΔ.	20.62.0007	20.62.0006	20.62.0005	20.62.0013	20.62.0012	20.62.0011
Μοντέλο	HDW12RW	HDW12RN	HDW12RC	HDW18RW	HDW18RN	HDW18RC

12W 112W 36W	IP40	SURFACE MOUNTING FRAME	Hole < 155MM >	800 LM	850 LM	900 LM	180-260V 50-60 Hz	CRI(RA) >80	PF >0.5	25.000 h	on/off >15 000
18W 168W 54W	IP40	SURFACE MOUNTING FRAME	Hole < 210MM >	1260 LM	1820 LM	1350 LM	180-260V 50-60 Hz	CRI(RA) >80	PF >0.5	25.000 h	on/off >15 000



HDWF20S 12W 18W

Προεραϊκά Εξαρτήματα Επιφανειακής Στήριξης

Watt	12W	12W	12W	18W
Lumen	800	850	900	1260
Voltage	180-260	180-260	180-260	180-260
CRI	>80	>80	>80	>80
Γωνία δέσμης	120°	120°	120°	120°
Θερμοκρασία	3000 K	4000 K	6500 K	3000 K
Διάρκεια ζωής	25 000 H	25 000 H	25 000 H	25 000 H
ON/OFF	> 15 000	> 15 000	> 15 000	> 15 000
Μέγεθος λάμπας	201.5x201.5x25.5mm	201.5x201.5x25.5mm	201.5x201.5x25.5mm	201.5x201.5x25.5mm
ΚΩΔ.	20.62.0010	20.62.0009	20.62.0008	20.62.0014
Μοντέλο	HDW12SW	HDW12SN	HDW12SC	HDW18SW

12W 112W 36W	IP40	SURFACE MOUNTING FRAME	Hole < 185MM >	800 LM	850 LM	900 LM	180-260V 50-60 Hz	CRI(RA) >80	PF >0.5	25.000 h	on/off >15 000
18W 168W 54W	IP40	SURFACE MOUNTING FRAME	Hole < 185MM >	1260 LM	1820 LM	1350 LM	180-260V 50-60 Hz	CRI(RA) >80	PF >0.5	25.000 h	on/off >15 000

**ΧΩΝΕΥΤΟ ΦΩΤΙΣΤΙΚΟ ΟΡΟΦΗΣ LED**

2700 K warm light

Watt	25W
Lumen	1800
Voltage	230 V
CRI	>80
Γωνία δέσμης	100°
Θερμοκρασία	2700 K
Διάρκεια ζωής	25 000 H
ON/OFF	> 15 000
Μέγεθος λάμπας	ø230 x 60 mm
<b>ΚΩΔ.</b>	<b>20.62.0019</b>
<b>Μοντέλο</b>	<b>HDW025</b>

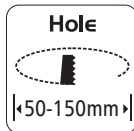
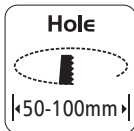
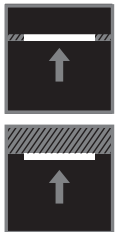

**25W** | **225W** | **72W**   
**IP 20** | | **IK 04** |   
**Hole** | | **ø200mm**  
**1800 lumen** | | **100°**  
**230V** | **50-60 Hz**  
**CRI(RA)** | **>80**  
**PF** | **>0.9**  
 | **25.000 h**  
 | **>15.000**  
**100% w<1s**

**ΦΩΤΙΣΤΙΚΟ ΟΡΟΦΗΣ LED**

**4000 K** natural light  
**6000 K** cold light

Watt	12W	18W
Lumen	1200	1820
Voltage	180-260 V	180-260 V
CRI	>80	>80
Γωνία δέσμης	100°	100°
Θερμοκρασία	4000 / 6000 K	4000 / 6000 K
Διάρκεια ζωής	25 000 H	25 000 H
ON/OFF	> 15 000	> 15 000
Μέγεθος λάμπας	ø166 x 18 mm	ø220 x 18 mm
<b>ΚΩΔ.</b>	<b>20.62.0016</b>	<b>20.62.0018</b>
<b>Μοντέλο</b>	<b>HDC12RN</b>	<b>HDC18RN</b>
<b>ΚΩΔ.</b>	<b>20.62.0015</b>	<b>20.62.0017</b>
<b>Μοντέλο</b>	<b>HDC12RC</b>	<b>HDC18RC</b>

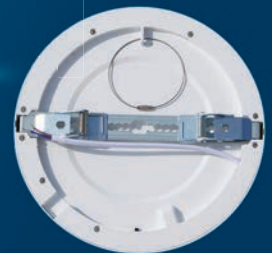

**12W** | **108W** | **35W**   
**18W** | **162W** | **52W**   
**IP20** |   
**1200 lumen** | | **100°**  
**180-260V** | **50-60 Hz**  
**CRI(RA)** | **>80**  
**PF** | **>0.5**  
 | **25.000 h**  
 | **>15.000**  
**100% w<1s**

## ΚΡΕΜΑΣΤΟ ΦΩΤΙΣΤΙΚΟ ΟΡΟΦΗΣ SUPREMO LED

OPTIONAL  
5 years  
Guarantee



- 50 000 h
- >15 000
- 100% (<1s)
- RoHS Compliant
- Energy Efficient

- 4000 K
- IP 44
- 3200 lumen Fixture
- 40W LED lamp
- 200-240V 50Hz
- 270°
- CRI(RA) >80
- Kelvin 4000
- F
- Hg

~50% Energy Save | 2 Years Guarantee

ΚΩΔ.	Μοντέλο	WATT	IP	Lumen	Volt	CRI	COS Φ	EAN	EEI	Dimensions
20.63.0981	LOP4002	40W	44	3200lm	200V-240V	>80	>0,9	5907377259862	G	ø 60 x 1200mm

## ΦΩΤΙΣΤΙΚΟ ΧΩΝΕΥΤΟ ΨΕΥΔΟΡΟΦΗΣ RONDO II LED

OPTIONAL  
5 years  
Guarantee



### Ρυθμιζόμενη θερμοκρασία χρώματος



- 3000 K
- 4000 K
- 6500 K

CCT διακόπτης για θερμοκρασία χρώματος



~85% Energy Save | 2 Years Guarantee

- 30 000 h
- >30 000
- 100% (<1s)
- RoHS Compliant

- 17W / 158W 55W
- IP44
- 1500 lumen
- 17W LED lamp
- 220-240V 50/60 Hz
- 90°
- CRI(RA) >80
- Kelvin 3000
- Kelvin 4000
- Kelvin 6000
- F
- Hg
- PF >0,9

- 25W / 256W 88W
- IP44
- 2400 lumen
- 25W LED lamp
- 220-240V 50/60 Hz
- 90°
- CRI(RA) >80
- Kelvin 3000
- Kelvin 4000
- Kelvin 6000
- F
- Hg
- PF >0,9

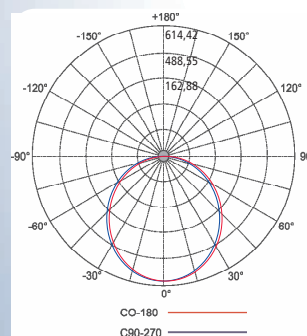

Hole	Fixture
ø145-155mm	ø174mm H-68,5mm

Hole	Fixture
ø195-210mm	ø244mm H-84mm

ΚΩΔ.	Μοντέλο	WATT	IP	Lumen	Volt	CRI	COS Φ	FAN	EEI	Dimensions
20.64.0353	LOR1705D	17W	20/44	1500lm	220V-240V	>80	>0,9	5901087205348	F	ø 174x68.5mm
20.64.0354	LOR2505D/E	25W	20/44	2400lm	220V-240V	>80	>0,9	5901087206130	F	ø 244x84mm



**ΦΩΤΙΣΤΙΚΟ ΧΩΝΕΥΤΟ ΨΕΥΔΟΡΟΦΗΣ RONDO Shine LED**
**LUMAX**  
Bright side of life

50 000 h

**Ρυθμιζόμενη θερμοκρασία χρώματος**

&gt;25 000

**LOR1705D 17W** **LOR2505D 25W**
**OPTIONAL**  
5 years  
Guarantee

100% (&lt;1s)

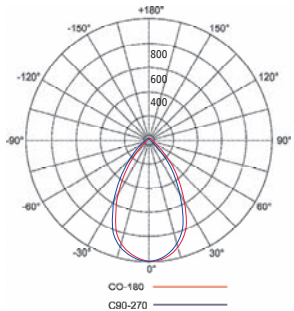

**CCT διακόπτης για θερμοκρασία χρώματος**

**Κάλυμμα επιφανειακής στήριξης για RONDO Shine**

**ΗΛΕΚΤΡΟΣΤΑΤΙΚΗ ΒΑΦΗ**

ΚΩΔ.	Μοντέλο	Περιγραφή	FAN	↔
20.66.0013	LORKWH	Προσαρμογέας επιφανειακής στήριξης για Rondo Shine λευκός	5901087205355	∅ 235 x 160mm
20.66.0012	LORKBL	Προσαρμογέας επιφανειακής στήριξης για Rondo Shine μαύρος	5901087205362	∅ 235 x 160mm

28W	311W 100W	IP20	lumen 3100 Fixture	28W LED lamp	220-240V 50/60 Hz	60°	CRI(RA) >80	Kelvin 3000	Kelvin 4000	Kelvin 6000	F	Hg	PF >0,9	Hole ∅195-210mm	Fixture ∅232mm H-112,8mm
-----	--------------	------	--------------------------	-----------------	-------------------------	-----	----------------	----------------	----------------	----------------	---	----	------------	--------------------	--------------------------------

35W	392W 126W	IP20	lumen 3400 Fixture	35W LED lamp	220-240V 50/60 Hz	60°	CRI(RA) >80	Kelvin 3000	Kelvin 4000	Kelvin 6000	F	Hg	PF >0,9	Hole ∅195-210mm	Fixture ∅232mm H-112,8mm
-----	--------------	------	--------------------------	-----------------	-------------------------	-----	----------------	----------------	----------------	----------------	---	----	------------	--------------------	--------------------------------

ΚΩΔ.	Μοντέλο	WATT	IP	Lumen	Beam	Volt	Color	CRI	cosφ Power Factor	FAN	EEI	↔
20.64.0355	LOR2805/E	28W	20	3100lm	60°	220V-240V	3000K/4000K/6000K	>80	>0,9	5901087202132	E	∅ Φ232x112.8mm
20.64.0352	LOR3505	35W	20	3400lm	60°	220V-240V	3000K/4000K/6000K	>80	>0,9	5901087202149	E	∅ Φ232x112.8mm

ΦΩΤΙΣΤΙΚΑ ΣΠΟΤ ΚΡΟΝΑ LED

OPTIONAL  
**5 years**  
Guarantee



- ANTI UV
- 20 000 h
- >20 000
- 100% (<1s)
- 



LIL061 6W

- IP 65
- IK 08
- lumen 240
- 6W
- 4000 Kelvin
- 230V Volt 50Hz
- 120°
- CRI(RA) >80
- PF >0.5



LIL121 12W

- IP 65
- IK 08
- lumen 550
- 12W
- 4000 Kelvin
- 230V Volt 50Hz
- 120°
- CRI(RA) >80
- PF >0.5



- ANTI UV
- 20 000 h
- >20 000
- 100% (<1s)
- 



LIL062 6W

- IP 65
- IK 08
- lumen 260
- 6W
- 4000 Kelvin
- 230V Volt 50Hz
- 120°
- CRI(RA) >80
- PF >0.5



LIL122 12W

- IP 65
- IK 08
- lumen 560
- 12W
- 4000 Kelvin
- 230V Volt 50Hz
- 120°
- CRI(RA) >80
- PF >0.5

ΚΩΔ.	Μοντέλο	WATT	IP	Lumen	Beam	Volt	Color	CRI	cosφ	FAN	EEL	Dimensions
20.64.0517	LIL061	6W	65	240lm	120°	230V	4000K	>80	>0.5	5907377252252	G	170x113x90 mm
20.64.0518	LIL062	6W	65	260lm	120°	230V	4000K	>80	>0.5	5907377252245	G	170x113x90 mm
20.64.0515	LIL121	12W	65	550lm	120°	230V	4000K	>80	>0.5	5907377252276	G	230x113x90 mm
20.64.0516	LIL122	12W	65	560lm	120°	230V	4000K	>80	>0.5	5907377252269	G	230x113x90 mm

## ΦΩΤΙΣΤΙΚΑ ΔΕΣΜΗΣ ASTON LED

**LUMAX**  
Bright side of life

OPTIONAL  
**5 years**  
Guarantee



**LOE061** 8W 4000 K

IP 65 IK 08 lumen 390 8W 4000 Kelvin 230V Volt 50Hz 120° CRI(RA) >80 PF >0.5



**LOE062** 8W 4000 K

IP 65 IK 08 lumen 390 8W 4000 Kelvin 230V Volt 50Hz 120° CRI(RA) >80 PF >0.5



**LOE033** 2.8W 4000 K

IP 65 IK 08 lumen 160 2.8W 4000 Kelvin 230V Volt 50Hz 120° CRI(RA) >80 PF >0.5



**LOE031** 3W 4000 K

IP 65 IK 08 lumen 110 3W 4000 Kelvin 230V Volt 50Hz 120° CRI(RA) >80 PF >0.5

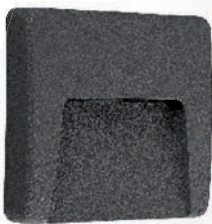

**LOE032** 3W 4000 K

IP 65 IK 08 lumen 100 3W 4000 Kelvin 230V Volt 50Hz 120° CRI(RA) >80 PF >0.5



**LOE034** 3W 4000 K

IP 65 IK 08 lumen 100 3W 4000 Kelvin 230V Volt 50Hz 120° CRI(RA) >80 PF >0.5



ΚΩΔ.	Μοντέλο	WATT	IP	Lumen	Beam	Volt	Color	CRI	cosφ	FAN	EEL	Size
20.64.0505	LOE061	8W	65	390lm	120°	230V	4000K	>80	>0.5	5907377252191	G	∅ 230x55 mm
20.64.0506	LOE062	8W	65	390lm	120°	230V	4000K	>80	>0.5	5907377252184	G	200x200x55 mm
20.64.0501	LOE031	3W	65	110lm	120°	230V	4000K	>80	>0.5	5907377252153	G	∅ 135x32 mm
20.64.0502	LOE032	3W	65	100lm	120°	230V	4000K	>80	>0.5	5907377252160	G	120x120x32 mm
20.64.0503	LOE033	2.8W	65	160lm	120°	230V	4000K	>80	>0.5	5907377257146	G	230X80X27 mm
20.64.0504	LOE034	3W	65	100lm	120°	230V	4000K	>80	>0.5	5907377252177	G	150X90X32 mm

ΦΩΤΙΣΤΙΚΟ ΧΩΝΕΥΤΟ ΔΑΠΕΔΟΥ GARDA LED

OPTIONAL  
5 years  
Guarantee

Φωτιστικό για MR16 με βάση GU10

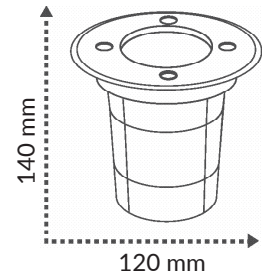
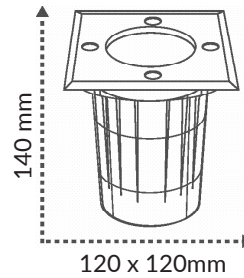

LGR52 IP65 GU10

LGR51 IP65 GU10

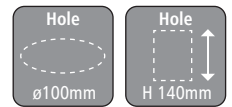

ΚΩΔ.	Μοντέλο	Φύση	MAX W	IP	Volt	FAN	Διάσταση
20.64.0509	LGR51	GU10	50W	65	220V-240V	5901087206994	120x140 mm
20.64.0510	LGR52	GU10	50W	65	220V-240V	5901087207007	120x120x140 mm

ΦΩΤΙΣΤΙΚΟ ΧΩΝΕΥΤΟ ΔΑΠΕΔΟΥ LUMIA LED

OPTIONAL  
5 years  
Guarantee

4000 K



IP 65 IK 04 lumen 55 1.2W 4000 Kelvin 230V Volt 50Hz 120° CRI(RA) >80 PF >0.4 20 000 h >20 000 100% (<1s)

ΚΩΔ.	Μοντέλο	WATT	IP	Lumen	Beam	Volt	CRI	cosφ Power Factor	FAN	EEL	Διάσταση
20.64.0507	LGR011	1,2W	65	55lm	120°	230V	4000K	>80	>0.4	5907377252207	G 100x100x74 mm
20.64.0508	LGR012	1,2W	65	55lm	120°	230V	4000K	>80	>0.4	5907377252214	G 100x100x74 mm

## ΑΠΛΙΚΕΣ AUDOR LED

OPTIONAL  
**5 years**  
Guarantee

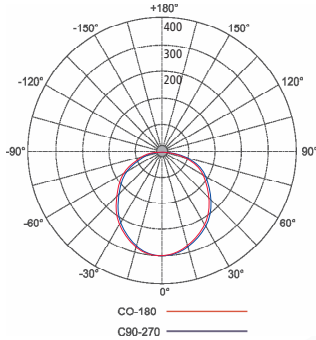
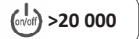
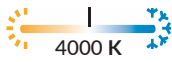

IP 65	IK 08	1000 lumen Fixture	12W LED lamp	220-240V 50Hz	120°	CRI(RA) >80	Kelvin 4000	PF >0.5
IP 65	IK 08	600 lumen Fixture	12W LED lamp	220-240V 50Hz	120°	CRI(RA) >80	Kelvin 4000	PF >0.5

ΚΩΔ.	Μοντέλο	WATT	IP	Lumen	Beam	Volt	Color	CRI	COSΦ Power Factor	FAN	EEL	Dimensions
20.64.0512	LOB123	12W	65	1000lm	120°	220-240V	4000K	>80	>0,5	5907377252221	G	230x110x76 mm
20.64.0513	LOB124	12W	65	600lm	120°	220-240V	4000K	>80	>0,5	5907377252238	G	230x110x76 mm

## ΑΠΛΙΚΑ PRIMA LED

OPTIONAL  
**5 years**  
Guarantee

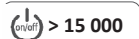

IP 65	IK 06	1500 lumen Fixture	15W LED lamp	220-240V 50Hz	120°	CRI(RA) >80	Kelvin 4000	PF >0.5	F	Hg
-------	-------	--------------------------	-----------------	------------------	------	----------------	----------------	------------	---	----

ΚΩΔ.	Μοντέλο	WATT	IP	Lumen	Beam	Volt	Color	CRI	COSΦ Power Factor	EAN	EEL	Dimensions
20.64.0514	LOB150	15W	65	1500lm	120°	220-240V	4000K	>80	>0,5	5901087210267	F	169x100mm

ΦΩΤΙΣΤΙΚΟ ΕΞΩΤΕΡΙΚΟΥ ΧΩΡΟΥ TORA

LUMAX®  
Bright side of life

OPTIONAL  
5 years  
Guarantee

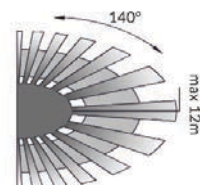

Height of installation: 1.8-2.5m

Detection Distance: Max 12m

SENSOR INFORMATION:

140° Detection Range	max 12m Detection distance	IP65
220-240V/AC 50/60 Hz	0.6-1.5m/s Detection Motion Speed	500W Additional switching capacity
Ambient light: <3-2000l Ux (adjustable)	-20~+40°C Working Temperature	1.8-2.5m Installing Height
Time delay: min 10sec. +1sec max 5min +1min	<93%RH Working Humidity	max 60W (E27) Rated Load



20 000 h	> 10 000	100% (<1s)		2700 K					
IP65	lumen 1000	8W LED lamp	220-240V 50Hz	140°	CRI(RA) >80	Kelvin 4000	PF >0.5	F	Hg

ΚΩΔ.	Μοντέλο	WATT	IP	Lumen	Angle	Volt	Color	CRI	COSφ	FAN	Dimensions
20.64.0511	LOB103	8W	65	1000lm	140°	220-240V	2700K	>80	>0,5	5901087209469	250x225x160mm

ΦΩΤΙΣΤΙΚΟ ΠΑΡΚΟΥ PARK MR

LUMAX®  
Bright side of life

OPTIONAL  
5 years  
Guarantee

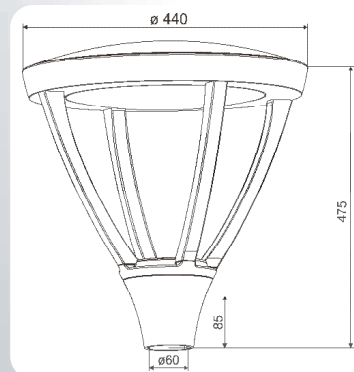
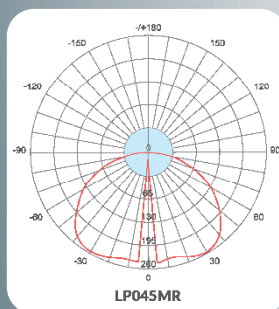

30 000 h	>25 000	100% (<1s)	
----------	---------	------------	--

<b>LP030MR</b> 30W	IP 65 IK 10	lumen 2650 Fixture	30W LED lamp	100-277V 50/60 Hz	90°	CRI(RA) >80	Kelvin 4000	F	Hg	PF >0,9
<b>LP045MR</b> 45W	IP 65 IK 10	lumen 4000 Fixture	45W LED lamp	100-277V 50/60 Hz	90°	CRI(RA) >80	Kelvin 4000	F	Hg	PF >0,9
<b>LP060MR</b> 60W	IP 65 IK 10	lumen 5300 Fixture	60W LED lamp	100-277V 50/60 Hz	90°	CRI(RA) >80	Kelvin 4000	F	Hg	PF >0,9

ΚΩΔ.	Μοντέλο	WATT	IP	Lumen	Angle	Volt	Color	CRI	COSφ	FAN	EEI	Dimensions
20.64.0859	LP030MR	30W	65	2650lm	90°	100-277V	4000K	>80	>0,9	-	F	ø 440x475 mm
20.64.0860	LP045MR	45W	65	4000lm	90°	100-277V	4000K	>80	>0,9	5901087206987	F	ø 440x475 mm
20.64.0861	LP060MR	60W	65	5300lm	90°	100-277V	4000K	>80	>0,9	-	F	ø 440x475 mm

**ΦΩΤΙΣΤΙΚΟ ΠΑΡΚΟΥ PARK MA**
**OPTIONAL**  
5 years  
Guarantee

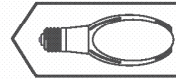
**E40**

Διατίθεται χωρίς την λάμπα.

 4950lm  
40W  
100-240V  
120°  
4000K  
PF>0,9

**LP001MA40** 40W

 IP 65  
IK 10



30 000 h

&gt;25 000

100% (&lt;1s)

**LP045MA1** 45W

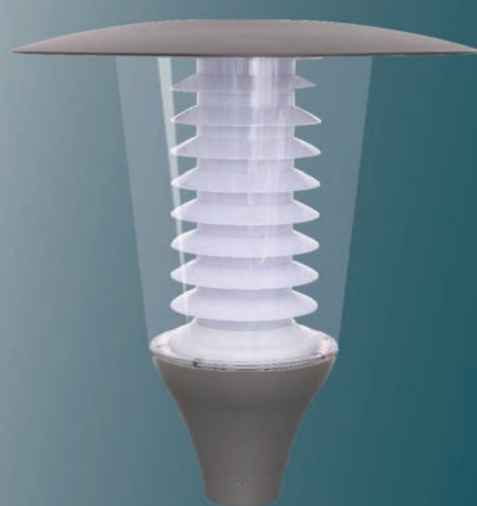
 IP 65  
IK 10

 lumen 4000  
45W LED lamp  
100-277V 50/60 Hz  
90°  
CRI(RA) >80  
Kelvin 4000  
F  
Hg  
PF >0,9

30 000 h

&gt;25 000

100% (&lt;1s)

**LP045MA2** 45W

 IP 65  
IK 10

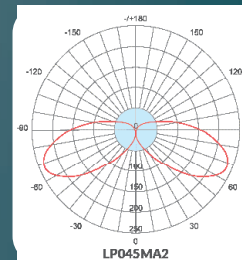
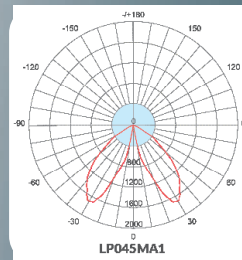
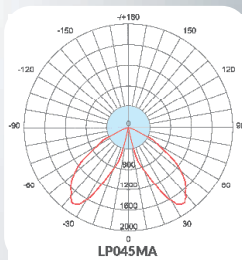
 lumen 2150  
45W LED lamp  
100-277V 50/60 Hz  
120°  
CRI(RA) >80  
Kelvin 4000  
F  
Hg  
PF >0,9

KΩΔ.	Μοντέλο	WATT	IP	Lumen	Beam	Volt	CRI	cosφ Power Factor	FAN	EEL	Dimensions
20.64.0852	LP001MA40	40W	65	4950lm	120°	100-277V	4000K	>0,9	-	E	ø 440x470 mm
20.64.0853	LP030MA1	30W	65	2650lm	90°	100-277V	4000K	>80	>0,9	F	ø 440x470 mm
20.64.0854	LP045MA1	45W	65	4000lm	90°	100-277V	4000K	>80	>0,9	F	ø 440x470 mm
20.64.0855	LP060MA1	60W	65	5300lm	90°	100-277V	4000K	>80	>0,9	F	ø 440x470 mm
20.64.0856	LP030MA2	30W	65	1400lm	120°	100-277V	4000K	>80	>0,9	G	ø 440x470 mm
20.64.0857	LP045MA2	45W	65	2150lm	120°	100-277V	4000K	>80	>0,9	G	ø 440x470 mm
20.64.0858	LP060MA2	60W	65	2800lm	120°	100-277V	4000K	>80	>0,9	G	ø 440x470 mm

ΦΩΤΙΣΤΙΚΟ ΔΡΟΜΟΥ RX LED

**LUMAX**  
Bright side of life

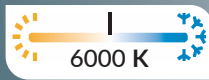
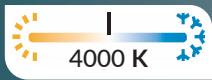

35 000 h

>30 000

100% (<1s)



OPTIONAL  
**3 years**  
Guarantee

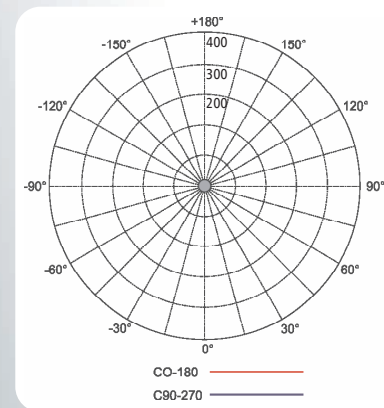
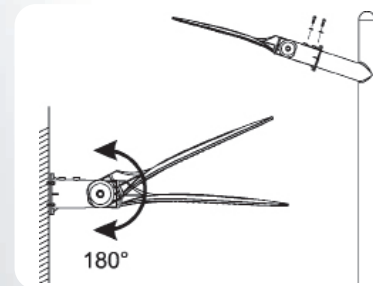

100W IP65 IK07 CRI(RA) >80 lumen 11000 4000 Kelvin 6000 Kelvin 185-265V 50Hz 130x90°

30W IP65 IK07 CRI(RA) >80 lumen 3300 4000 Kelvin 6000 Kelvin 185-265V 50Hz 130x90° 150W IP65 IK07 CRI(RA) >80 lumen 16500 4000 Kelvin 6000 Kelvin 185-265V 50Hz 130x90°

60W IP65 IK07 CRI(RA) >80 lumen 6600 4000 Kelvin 6000 Kelvin 185-265V 50Hz 130x90° 200W IP65 IK07 CRI(RA) >80 lumen 22000 4000 Kelvin 6000 Kelvin 185-265V 50Hz 130x90°

ΚΩΔ.	Μοντέλο	WATT	IP	Lumen	Beam	Volt	Color	CRI	COS Φ	FAN	EEI	mounting hole	Dimensions
20.64.0651	LU030RX	30W	65	3300lm	130x90°	185-265V	6000K	>80	>0,9	5901087204327	E	62mm	491x165x88mm
20.64.0652	LU030RXN	30W	65	3300lm	130x90°	185-265V	4000K	>80	>0,9	5901087204334	E	62mm	491x165x88mm
20.64.0653	LU060RX	60W	65	6600lm	130x90°	185-265V	6000K	>80	>0,9	5901087203740	E	62mm	491x165x88mm
20.64.0654	LU060RXN	60W	65	6600lm	130x90°	185-265V	4000K	>80	>0,9	5901087204341	E	62mm	491x165x88mm
20.64.0655	LU100RX	100W	65	11000lm	130x90°	185-265V	6000K	>80	>0,9	5901087203757	E	62mm	572x201x97mm
20.64.0656	LU100RXN	100W	65	11000lm	130x90°	185-265V	4000K	>80	>0,9	5901087204358	E	62mm	572x201x97mm
20.64.0657	LU150RX	150W	65	16500lm	130x90°	185-265V	6000K	>80	>0,9	5901087203764	E	62mm	645x246x97mm
20.64.0658	LU150RXN	150W	65	16500lm	130x90°	185-265V	4000K	>80	>0,9	5901087204365	E	62mm	645x246x97mm
20.64.0659	LU200RX	200W	65	22000lm	130x90°	185-265V	6000K	>80	>0,9	5901087209889	E	62mm	707x282x97mm
20.64.0660	LU200RXN	200W	65	22000lm	130x90°	185-265V	4000K	>80	>0,9	5901087209896	E	62mm	707x282x97mm



## ΦΩΤΙΣΤΙΚΟ ΔΡΟΜΟΥ MA LED

- 50 000 h
- > 50 000
- (<1s)
- 

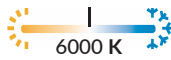
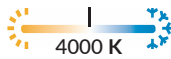

**OPTIONAL**  
5 years  
Guarantee

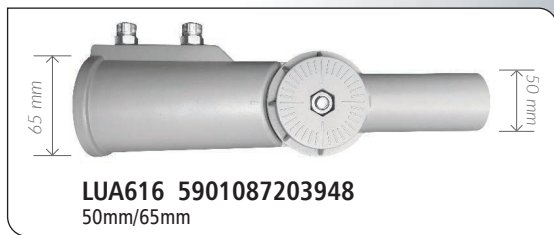

**LU030MA 30W 3600lm**

30W IP65 CRI(RA) >70 lumen 3600 90 -264V 50Hz 130x60°

**LU060MA 60W 7200lm**

60W IP65 CRI(RA) >70 lumen 7200 90 -264V 50Hz 130x60°

**LU100MA 100W 12000lm**

100W IP65 CRI(RA) >70 lumen 12000 90 -264V 50Hz 130x60°

**LU120MA 120W 14400lm**

120W IP65 CRI(RA) >70 lumen 14400 90 -264V 50Hz 130x60°

**LU150MA 150W 18000lm**

150W IP65 CRI(RA) >70 lumen 18000 90 -264V 50Hz 130x60°

**LU180MA 180W 21600lm**

180W IP65 CRI(RA) >70 lumen 21600 90 -264V 50Hz 130x60°

ΚΩΔ.	Μοντέλο	WATT	IP	Lumen	Beam angle	Volt	Color	CRI	COSΦ Power Factor	FAN	EEL	mounting hole	Dimensions
20.64.0661	LU030MA	30W	65	3600lm	130x60°	90-264V	6000K	>70	>0,95	5907377252351	E	ø 50 mm	398x157x82 mm
20.64.0662	LU030MAN	30W	65	3600lm	130x60°	90-264V	4000K	>70	>0,95	5901087201753	E	ø 50 mm	398x157x82 mm
20.64.0663	LU060MA	60W	65	7200lm	130x60°	90-264V	6000K	>70	>0,95	5907377252368	E	ø 50 mm	453x187x67 mm
20.64.0664	LU060MAN	60W	65	7200lm	130x60°	90-264V	4000K	>70	>0,95	5901087201760	E	ø 50 mm	453x187x67 mm
20.64.0665	LU100MA	100W	65	12000lm	130x60°	90-264V	6000K	>70	>0,95	5907377252375	E	ø 50/60 mm	534x258x72 mm
20.64.0666	LU100MAN	100W	65	12000lm	130x60°	90-264V	4000K	>70	>0,95	5901087201777	E	ø 50/60 mm	534x258x72 mm
20.64.0687	LU120MA	120W	65	14400lm	130x60°	90-264V	6000K	>70	>0,95	---	E	ø 50/60 mm	534x258x72 mm
20.64.0688	LU120MAN	120W	65	14400lm	130x60°	90-264V	4000K	>70	>0,95	---	E	ø 50/60 mm	534x258x72 mm
20.64.0667	LU150MA	150W	65	18000lm	130x60°	90-264V	6000K	>70	>0,95	---	E	ø 50/60 mm	701x270x79 mm
20.64.0684	LU150MAN	150W	65	18000lm	130x60°	90-264V	4000K	>70	>0,95	---	E	ø 50/60 mm	701x270x79 mm
20.64.0685	LU180MA	180W	65	21600lm	130x60°	90-264V	6000K	>70	>0,95	---	E	ø 50/60 mm	701x270x79 mm
20.64.0686	LU180MAN	180W	65	21600lm	130x60°	90-264V	4000K	>70	>0,95	---	E	ø 50/60 mm	701x270x79 mm

ΦΩΤΙΣΤΙΚΑ ΓΡΑΦΕΙΟΥ LED



20.10.1107

ΚΩΔΙΚΟΣ	ΜΟΝΤΕΛΟ	Lumen	Watt	Kelvin	Χρώμα	Συσκ.
20.10.1107	L09	350	5	4000	Μαύρο/Λευκό	1
20.10.1108	L15	350	5	4000	Μαύρο/Λευκό	1

L09 - 10.1107:

- Υψηλής Φωτεινότητας: SMD LED
- Περιστροφή βραχίονα: 90°
- Περιστροφή φωτιστικού: 360°
- Διαστάσεις: 390x120x340mm

L15 - 10.1108:

- Υψηλής Φωτεινότητας: SMD LED
- Περιστροφή φωτιστικού: 360°
- Φωτισμός: 180°
- Διάμετρος: Φ160



20.10.1108

ΦΩΤΙΣΤΙΚΑ ΓΡΑΦΕΙΟΥ-ΣΧΕΔΙΑΣΤΗΡΙΟΥ E27



20.10.1101



20.10.1103



20.10.1102

ΚΩΔΙΚΟΣ	ΜΟΝΤΕΛΟ	Λάμπα	Χρώμα	Συσκ.
20.10.1101	966	Μαx 40W E27	Μαύρο/Λευκό/Κόκκινο	1
20.10.1102	811	Μαx 40W E27	Μαύρο/Λευκό/Κόκκινο	1
20.10.1103	812	Μαx 40W E27	Μαύρο/Λευκό	1

966 - 10.1101:

- Μεταλλική κατασκευή
- Ευέλικτη κεφαλή πολλαπλών κατευθύνσεων
- Διακόπτης: On/Off
- Ρυθμιζόμενος Βραχίονας

812 - 10.1103:

- Μεταλλική κατασκευή με Μέγγενη
- Ευέλικτη κεφαλή πολλαπλών κατευθύνσεων
- Διακόπτης: On/Off
- Ρυθμιζόμενος Βραχίονας

811 - 10.1102:

- Μεταλλική κατασκευή
- Ευέλικτη κεφαλή πολλαπλών κατευθύνσεων
- Διακόπτης: On/Off
- Ρυθμιζόμενος Βραχίονας

# KARSON AEBE

## 91 χρόνια παρουσίας & πρωτοπορίας

Η Εταιρεία **KARSON AEBE** έχει κατακτήσει μια ηγετική θέση προσφέροντας λύσεις Ηλεκτρολογικού Υλικού, Φωτισμού & Αυτόματου Ελέγχου σε συνδυασμό με Συστήματα Θυροτηλεοράσεων, Ασφαλείας, αυτοματισμούς θυρών & Εποχικών Υλικών.

Σε όλη τη διάρκεια της μακρόχρονης πορείας της η **KARSON** έχει αναλάβει από τα μεγαλύτερα πανελλαδικώς έργα, ενώ το 2002 εξόπλισε τα Ολυμπιακά Χωριά Αθλητών και Δημοσιογράφων με συστήματά της. Αποστολή της **KARSON**, όπως την αντιλαμβάνονται και την υλοποιούν καθημερινά οι εργαζόμενοι σε αυτήν, είναι η απόλυτη ικανοποίηση

των πελατών της με αποτελεσματικό, αξιόπιστο & καινοτόμο τρόπο. Παράλληλα, κύριο μέλημα της Εταιρείας είναι η υψηλή ποιότητα των προϊόντων που εισάγει και οι ανταγωνιστικές της τιμές ώστε να συνεχίζει να διατηρεί το άριστο όνομα που έχει στην αγορά.

Το δίκτυο συνεργατών της **KARSON** εκτείνεται σε όλη την Ελλάδα. Οι εγκαταστάσεις της Εταιρείας, επιφάνειας 5.000 τ.μ. στεγασμένων χώρων, είναι στην περιοχή του Βοτανικού, όπου συγκεντρώνονται οι διοικητικές, εμπορικές & τεχνικές υπηρεσίες της, καθώς και οι αποθηκευτικοί χώροι

### ΣΥΣΤΗΜΑΤΑ ΘΥΡΟΤΗΛΕΦΩΝΩΝ & ΘΥΡΟΤΗΛΕΟΡΑΣΕΩΝ - ΙΤΑΛΙΑΣ & ΚΟΡΕΑΣ

**urmet**

**COMMAX**

Παγκόσμιος ηγέτης στον τομέα του ο Ιταλικός όμιλος **URMET** παρουσίασε πριν 60 χρόνια τα πρώτα συστήματα θυροτηλεοράσεων παγκοσμίως. Η **KARSON AEBE** εγκατέστησε τα πρώτα συστήματα θυροτηλεοράσεων στην Ελλάδα το 1974. Ο Όμιλος **URMET** διαθέτει την μεγαλύτερη ποικιλία μοντέλων στην αγορά και αναλογικές και ψηφιακές μεθόδους εγκατάστασης για μέγιστη ευελιξία.

Τεχνολογικές Λύσεις Αιχμής Κορέας



### ΜΕΛΩΔΙΚΑ & ΑΣΥΡΜΑΤΑ ΚΟΥΔΟΥΝΙΑ - ΓΑΛΛΙΑΣ & ΑΓΓΛΙΑΣ

**SCS sentinel**

**Honeywell**

**Friedland**

Η **SCS SENTINEL** Γαλλίας, Εταιρεία του ομίλου **URMET**, συγκαταλέγεται στους μεγαλύτερους προμηθευτές στην Ευρώπη σε Κουδούνια, αυτοματισμούς & ηλεκτρονικές συσκευές, με οικονομικές λύσεις υψηλής ποιότητας, πρωτοτυπία & προσεγγίση συσκευασίας των προϊόντων. Από το 2011 αντιπροσωπεύεται από την **KARSON** με μια στρατηγική συνεργασία για την αναβαθμισμένη εξυπηρέτηση των πελατών της.

Η **Friedland** Αγγλίας εδώ και 75 χρόνια είναι ο κορυφαίος κατασκευαστής κουδουνιών στον κόσμο, και πλέον προωθείται υπό την ονομασία του παγκόσμιου Οίκου πρωτοποριακής τεχνολογίας, την **Honeywell**. Η συνεργασία με την **KARSON** είναι από το 1965 έτσι ώστε τα κουδούνια **Friedland** να βρίσκονται σε κατοικίες σε όλες τις γωνιές της Ελλάδας.



### ΗΛΕΚΤΡΟΛΟΓΙΚΟ ΥΛΙΚΟ - ΦΩΤΙΣΜΟΣ - ΣΥΣΚΕΥΕΣ ΑΥΤΟΜΑΤΟΥ ΕΛΕΓΧΟΥ - ΙΣΠΑΝΙΑΣ, ΓΕΡΜΑΝΙΑΣ

**led**  
**IVERLUX**  
**ORBIS**  
**VARTA**

Η **KARSON**, από τους πρωτοπόρους εισαγωγείς Φωτισμού & Ηλεκτρολογικού Υλικού στην Ελλάδα, έχει επεκτείνει την γκάμα προϊόντων με νέες σειρές σύγχρονης τεχνολογίας & καταξιωμένων συνεργαζόμενων κατασκευαστών τόσο στις σειρές φωτισμού **KaraLED**, όσο και με την ήδη 20χρονη αντιπροσώπηση της Ισπανικής Εταιρείας Φωτισμού Ασφαλείας **Iverlux** αλλά και τις μακρόχρονες συνεργασίες με την Ισπανική **Orbis** στις Συσκευές Αυτόματου Ελέγχου & της Γερμανικής **VARTA** σε φακούς & μπαταρίες.



### ΣΥΣΤΗΜΑΤΑ ΑΣΦΑΛΕΙΑΣ: ΣΥΝΑΓΕΡΜΟΙ - ΚΛΕΙΣΤΟ ΚΥΚΛΩΜΑ CCTV - SMART HOME WiFi

**urmet**  
**SCS sentinel**  
**Honeywell**  
**ELKRON**

Συνεργασίες με ορισμένους από τους πιο ισχυρούς Προμηθευτές συστημάτων ασφαλείας για ποικίλες λύσεις μέσης & υψηλής Ασφάλειας οικιακών συστημάτων έως και μεγαλύτερες εγκαταστάσεις, υπό την άρτια υποστήριξη του Τεχνικού Τμήματος της **KARSON**



### ΑΥΤΟΜΑΤΙΣΜΟΙ ΘΥΡΩΝ & ΠΑΡΑΘΥΡΩΝ

**SCS sentinel**  
**Aprimatic**

Πλήρης σειράς υδραυλικών & μηχανικών αυτοματισμών για ανοιγόμενες και συρόμενες πόρτες, γκαραζόπορτες, ροιά, μπάρες



### ΕΠΟΧΙΚΟ ΥΛΙΚΟ: ΑΝΕΜΙΣΤΗΡΕΣ - ΕΝΤΟΜΟΚΤΟΝΑ - ΘΕΡΜΑΝΤΙΚΑ

**BRAND**  
**GRAND THERMAL**

Τέσσερις δεκαετίες διαρκούς & επιτυχημένης πορείας στα Εποχικά, με διαρκώς αυξανόμενη γκάμα οικιακών και επαγγελματικών λύσεων, αναβαθμισμένα χαρακτηριστικά και μεγάλη προσοχή στην ποιότητα





**ΑΝΩΝΥΜΟΣ ΒΙΟΜΗΧΑΝΙΚΗ & ΕΜΠΟΡΙΚΗ ΕΤΑΙΡΕΙΑ ΗΛΕΚΤΡΙΚΩΝ ΕΙΔΩΝ**  
**ΑΓΙΟΥ ΠΑΝΤΕΛΗΜΟΝΟΣ 3, ΑΙΓΑΛΕΩ, Τ.Κ.: 12241, ΑΘΗΝΑ**  
**ΤΗΛΕΦ. ΚΕΝΤΡΟ: 210 34 64 461 - ΠΑΡΑΓΓΕΛΙΕΣ: 210 34 67 342**  
**E-mail: [sales@karson.gr](mailto:sales@karson.gr)**